



PREMIUM-WERKZEUGE



PREMIUM TOOLS



www.kstools.com

NON SPARKING TOOLS

Explosion protection after **ATEX** = **AT**mosphere **EX**plosible

Directive 137 (also known as directive 99/92) determines that the end user (employer) is responsible for the safety of the employees working (installing, operating or maintaining equipment) in a potentially explosive atmosphere.

The directive has been in force since July 2003.

Classification of the zones by explosion risks

ATEX Feasibility	high	average-low	very low
Gases	ZONE 0 is an area, in which dangerous atmosphere capable of explosion as a mixture from air and combustible gases, damping or fogs exists constantly, for long time or frequently. The notion „frequently“ is to be used for means of „temporally mainly „, which means that explosion-endangered areas are to be assigned zone 0, if the atmosphere is capable of explosion for more than 50% during the working duration of an arrangement. Actually, this is only inside tubes and reservoirs the case.	ZONE 1 is an area in which at normal working duration, occasionally a dangerous atmosphere is capable of explosion as a mixture from air and combustible gases, damping or fogs. If the existence of atmosphere capable of explosion comes to a duration of approximately 30 minutes per year or this appears occasionally, e.g. daily, however, it is smaller than 50% of the activity duration of the arrangement, zone 1 applies according to general opinion.	ZONE 2 is an area in which at normal working duration, occasionally a dangerous atmosphere is capable of explosion as a mixture from air and combustible gas, damping or fogs. Among a number of experts the general consensus consists the fact that the notion corresponds „briefly“ to a duration of approximately 30 minutes per year. Furthermore it is stated that atmosphere capable of explosion is not to be expected at normal activity usually. If atmosphere capable of explosion already appears once a year briefly, the affected area should be already classified in zone 2.
Dust	ZONE 20 is an area in which dangerous atmosphere, that is capable of explosion, exists in form of a cloud in the air which contains combustible dust constantly, for long time or frequently.	ZONE 21 is an area in which at normal activity occasionally a dangerous atmosphere capable of explosion exists in form of a cloud in the air which contains combustible dust.	ZONE 22 is an area in which at normal activity a dangerous atmosphere capable of explosion does not appear in form of a cloud in the air which contains combustible dust usually or, however, only briefly.

Application remarks:

- Non sparking tools are softer than usual tools. The operation with these tools has to be carried out with accuracy and care. Overstraining has to be prevented.
- Only using non sparking tools as a protection measure in fire endangered and explosion endangered areas is not enough. Please consider the instructions of local health and safety regulations for the protection of employees and accommodation.

Reworking:

- Technical marking sheets are available on request for reworking (e.g. re-sharpen).



BERYLLIUMplus

Material	Be	Ni+Co	Impurity		Balance
min in %	1.8	0.2			Cu
max in %	2.0	0.8	0.5		
Technical properties	800-940 Mp (average value 850 Mp)				
Tensile strength	HRC35-42				
Hardness	8,5 (average value)				
Specific weight	1.0004				
Magnetic characteristics	0,53079 S/m				
Electrical conduction					

BRONZEplus

Material	Al	Ni	Fe	Mn	Balance
min in %	9.0	4.0	4.0	0.8	Cu
max in %	10.0	5.0	5.0	2.5	
Technical properties	700-740 Mp (average value 725 Mp)				
Tensile strength	120 Mp				
Yield stress	HRC25-32				
Hardness	7,5 (average value)				
Specific weight	1.348				
Magnetic characteristics	0,42463 S/m				
Electrical conduction					

Non sparking tool - lines

BRONZE *plus*

- Non-sparking
- Explosion proof
- Corrosion resistant
- Wear resistant
- Aluminium-Bronze (Non-Ferrous-Alloy)

BERYLLIUM *plus*

- Non-sparking
- Explosion proof
- Corrosion resistant
- Very breakage resistant
- Copper Beryllium (Non-Ferrous-Alloy)

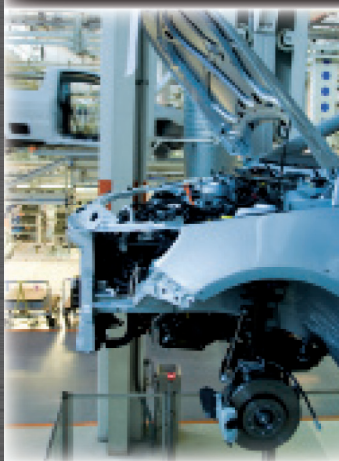

Applications BERYLLIUMplus / BRONZEplus

- Chemical industries
- Petro refineries
- Oil and gas carriages
- Pipeline business
- Drilling platforms
- Fuel service (cleaning etc.)
- Gas and electricity works
- Varnishing
- Federal armed forces, army
- Civil defence and civil protection
- Fire department

You can use it on all places where sparks create potential danger of explosion and fire. For the activities which require the use (application) of a hundred percent non-magnetic and extremely rustproof tools.



NON SPARKING HOSE COUPLING WRENCHES & HOOK WRENCHES

BRONZEplus Coupling spanner A-B-C

- For fire brigade (Storz) couplings A - B - C
- Non-sparking
- Explosion proof
- Corrosion resistant
- Wear resistant
- Aluminium-Bronze (Non-Ferrous-Alloy)



	Ø mm	L mm	kg	€
963.8205	14	440,0	800	200,50

BRONZEplus Coupling spanner B-C

- For fire brigade (Storz) couplings B - C
- Handle insulated with plastic against cold
- Non-sparking
- Explosion proof
- Corrosion resistant
- Wear resistant
- Aluminium-Bronze (Non-Ferrous-Alloy)

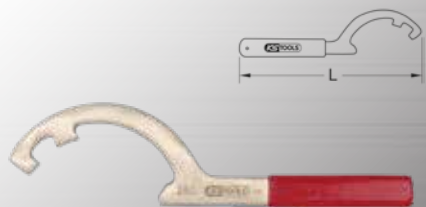

	Ø mm	L mm	kg	€
963.8206	12	280,0	450	42,90

BRONZEplus hook wrench with spigot

- In accordance to DIN 1810 Form B
- With spigot for for cross drilled nuts to DIN 1816
- Non-sparking
- Explosion proof
- Corrosion resistant
- Wear resistant
- Aluminium-Bronze (Non-Ferrous-Alloy)

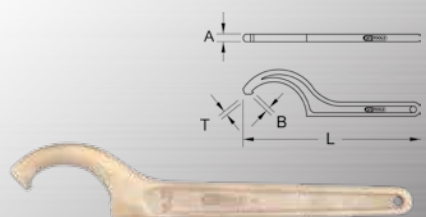

	Span width mm	A mm	B mm	L mm	T mm	kg	€
963.8210	12-14	3,0	1,5	110,0	2,0	0,03	29,90
963.8211	16-20	3,0	2	110,0	2,5	0,03	34,50
963.8212	25-28	4,0	2,5	135,0	3,0	0,05	36,50
963.8213	30-32	4,0	2,5	135,0	4,0	0,05	36,50
963.8214	34-36	5,0	3	170,0	4,0	0,10	39,50
963.8215	40-42	5,0	3	170,0	4,0	0,10	39,50
963.8216	45-50	6,0	3,5	205,0	5,0	0,19	39,50
963.8217	52-55	6,0	3,5	205,0	5,0	0,19	48,50
963.8218	58-62	7,0	4	240,0	5,0	0,24	54,50
963.8219	68-75	7,0	4	240,0	6,0	0,20	64,50
963.8220	80-90	8,0	5	280,0	6,0	0,41	75,90
963.8221	95-100	8,0	5	280,0	8,0	0,41	94,50
963.8222	110-115	10,0	6	335,0	8,0	0,73	112,50
963.8223	120-130	10,0	6	335,0	8,0	0,73	139,50
963.8224	135-145	12,0	7	390,0	8,0	1,15	170,50
963.8225	155-165	12,0	7	390,0	8,0	1,15	230,50
963.8226	180-195	14,0	8	465,0	10,0	1,41	320,90
963.8227	205-220	14,0	8	465,0	10,0	1,84	381,90

BRONZEplus pivot hook wrench with pin

- In accordance to DIN 1810 Form A
- With pin for for slotted nuts to DIN 981
- Non-sparking
- Explosion proof
- Corrosion resistant
- Wear resistant
- Aluminium-Bronze (Non-Ferrous-Alloy)

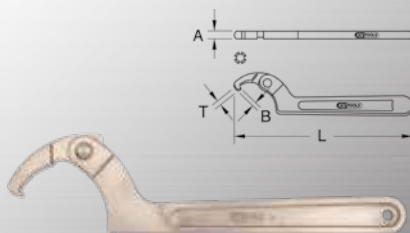

	Span width mm	A mm	B mm	L mm	T mm	kg	€
963.8207	32-75	8,0	6,0	205,0	5,0	230	94,50
963.8208	50-120	10,0	7,0	285,0	6,0	450	118,90
963.8209	115-170	12,0	10,0	310,0	7,0	500	170,50

NON SPARKING SPECIAL BITS

BRONZEplus Slide claw

- Handle insulated with plastic against cold
- Non-sparking
- Explosion proof
- Corrosion resistant
- Wear resistant
- Aluminium-Bronze (Non-Ferrous-Alloy)

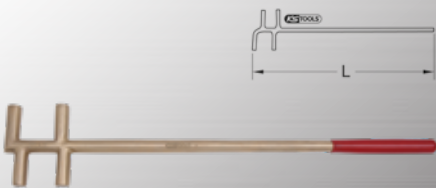

	mm	L mm	kg	€
963.8228	30-40	500,0	720	248,50

BRONZEplus valve hook

- Non-sparking
- Explosion proof
- Corrosion resistant
- Wear resistant
- Aluminium-Bronze (Non-Ferrous-Alloy)

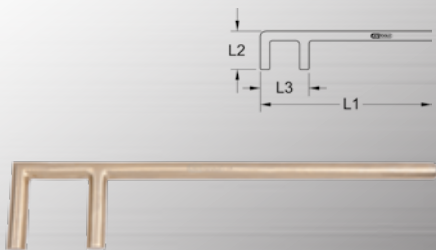

	Ø mm	L1 mm	L2 mm	L3 mm	kg	€
963.8229	13	300,0	50,0	30,0	0,35	97,50
963.8230	13	350,0	55,0	35,0	0,60	133,90
963.8231	16	400,0	60,0	40,0	0,68	145,50
963.8232	16	450,0	65,0	45,0	1,10	163,90
963.8233	19	500,0	70,0	50,0	1,20	187,50
963.8234	22	600,0	75,0	60,0	2,00	223,90
963.8235	25	700,0	80,0	70,0	3,00	302,90
963.8236	28	800,0	85,0	80,0	5,30	350,90

BRONZEplus Face pin spanner

- Non-sparking
- Explosion proof
- Corrosion resistant
- Wear resistant
- Aluminium-Bronze (Non-Ferrous-Alloy)

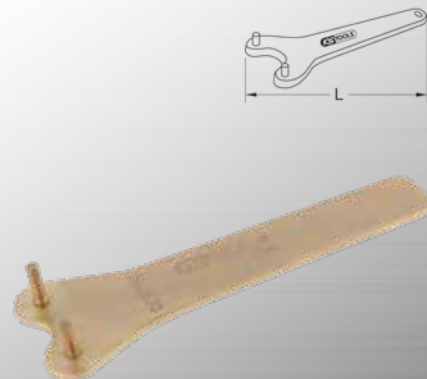

	Pin key mm	Stud Ø mm	L mm	kg	€
963.8237	35,0	5,0	180,0	150	145,50

BRONZEplus Adjustable face pin spanner

- Non-sparking
- Explosion proof
- Corrosion resistant
- Wear resistant
- Aluminium-Bronze (Non-Ferrous-Alloy)



	Stud Ø mm	High pin height mm	Length mm	kg	€
963.0029	3,0	4,0	160,0	75	52,50

BRONZEplus hand key

- In accordance to DIN 87311
- Handle insulated with plastic against cold
- Non-sparking
- Explosion proof
- Corrosion resistant
- Wear resistant
- Aluminium-Bronze (Non-Ferrous-Alloy)

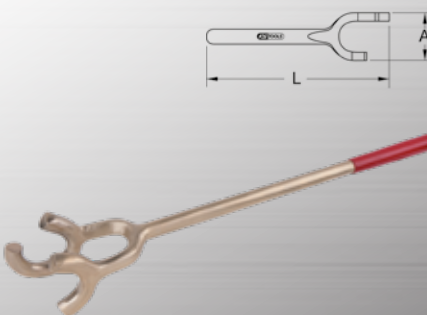

	Ø mm	A mm	L mm	kg	€
963.8238	36x60	60,0	370,0	0,65	223,90
963.8239	48x80	80,0	430,0	2,60	302,90
963.8240	62x102	102,0	550,0	1,30	393,90

BRONZEplus B-hand key

- In accordance to DIN 87311
- Handle insulated with plastic against cold
- Non-sparking
- Explosion proof
- Corrosion resistant
- Wear resistant
- Aluminium-Bronze (Non-Ferrous-Alloy)

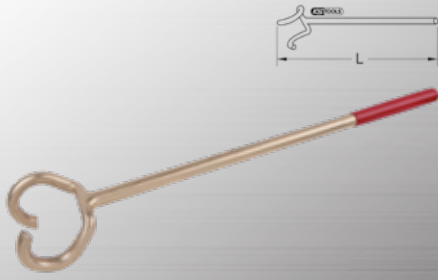

	Ø mm	L mm	kg	€
963.8241	36x60	330,0	0,60	291,50
963.8242	48x80	470,0	1,40	418,50
963.8243	62x102	600,0	2,60	539,50

BRONZEplus universal barrel key

- For current plug cover caps
- Non-sparking
- Explosion proof
- Corrosion resistant
- Wear resistant
- Aluminium-Bronze (Non-Ferrous-Alloy)

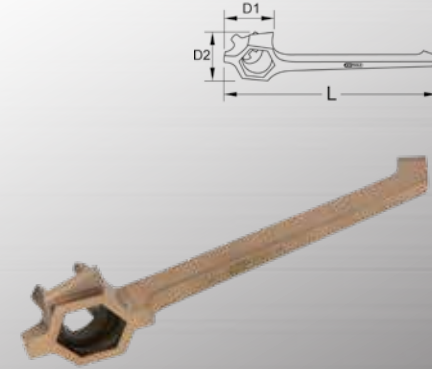

	D1 mm	D2 mm	L mm	kg	€
963.8271	38,0	52,0	300,0	600	118,90

BRONZEplus Sewer lid hook, reinforced

- Non-sparking
- Explosion proof
- Corrosion resistant
- Wear resistant
- Aluminium-Bronze (Non-Ferrous-Alloy)



	L mm	kg	€
963.8274	700,0	1,20	200,50

BRONZEplus Spanner for tanker valve

- Non-sparking
- Explosion proof
- Corrosion resistant
- Wear resistant
- Aluminium-Bronze (Non-Ferrous-Alloy)

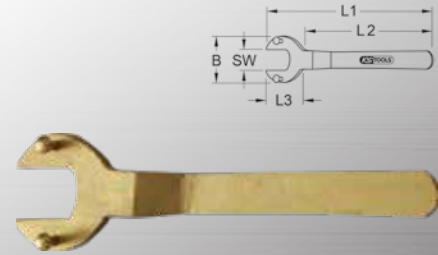

	Type	Ø mm	Stud Ø mm	B mm	L1 mm	L2 mm	L3 mm	kg	€	
963.8244	A	64,0	32,0	20,0	90,0	660,0	500,0	160,0	1,80	381,90
963.8245	B	64,0	32,0	20,0	90,0	650,0	500,0	150,0	1,60	418,50
963.8246	C	95,0	47,5	20,0	90,0	690,0	500,0	190,0	2,50	448,50

BRONZEplus universal barrel key

- For current barrel clasps
- Non-sparking
- Explosion proof
- Corrosion resistant
- Wear resistant
- Aluminium-Bronze (Non-Ferrous-Alloy)

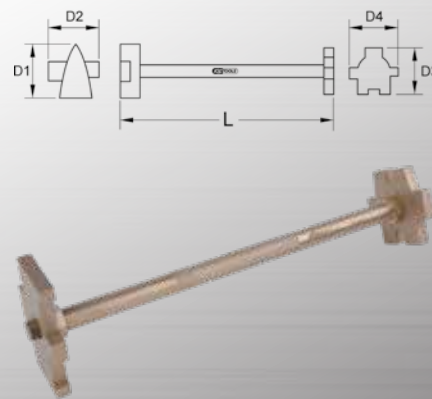

	D1 mm	D2 mm	D3 mm	D4 mm	L mm	kg	€
963.8272	70,0	70,0	65,0	95,0	400,0	1,70	151,90

NON SPARKING BOX SPANNERS

BRONZEplus box spanner, offset

- 4 point
- Non-sparking
- Explosion proof
- Corrosion resistant
- Wear resistant
- Aluminium-Bronze (Non-Ferrous-Alloy)

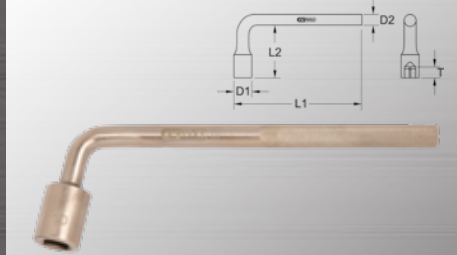

	Ø mm	D1 mm	D2 mm	L1 mm	L2 mm	T mm	kg	€
963.8247	8	18,0	8,0	150,0	33,0	15,0	90	88,90
963.8248	9	20,0	8,0	160,0	35,0	15,0	100	94,50
963.8249	10	22,0	8,0	175,0	37,0	15,0	120	102,90
963.8250	12	24,0	10,0	215,0	42,0	18,0	220	102,90
963.8251	13	26,0	10,0	230,0	45,0	18,0	280	112,50
963.8252	14	27,0	12,0	240,0	45,0	18,0	280	112,50
963.8253	17	32,0	14,0	280,0	51,0	22,0	330	112,50

BRONZEplus universal barrel key

- For 22 barrel clasps
- Non-sparking
- Explosion proof
- Corrosion resistant
- Wear resistant
- Aluminium-Bronze (Non-Ferrous-Alloy)

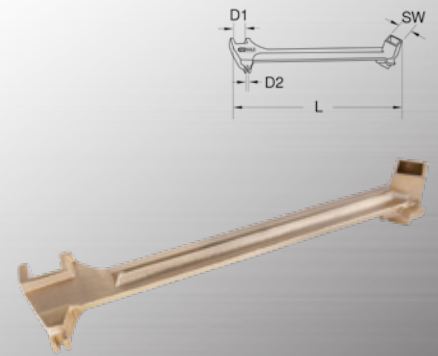

	mm	L mm	D1 mm	D2 mm	kg	€
963.8270	18 x 22	380,0	27,0	6,0	1,25	139,50

BRONZEplus Sewer lid hook

- Non-sparking
- Explosion proof
- Corrosion resistant
- Wear resistant
- Aluminium-Bronze (Non-Ferrous-Alloy)

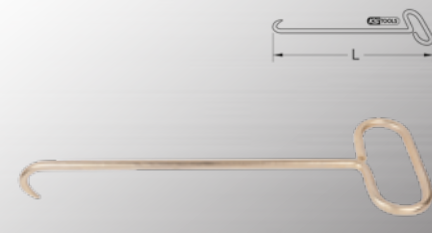

	L mm	kg	€
963.8273	500,0	770	145,50

BRONZEplus socket

- 3-point
- In accordance to DIN 3124 / ISO 2725-1
- Internal square to DIN 3120 / ISO 1174 with ball reception
- Non-sparking
- Explosion proof
- Corrosion resistant
- Wear resistant
- Aluminium-Bronze (Non-Ferrous-Alloy)

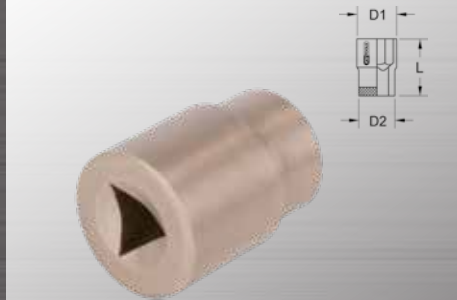

	Ø mm	D1 mm	D2 mm	L mm	kg	€
963.8254	6	16,0	25,0	40,0	70	46,50
963.8255	8	18,0	25,0	40,0	80	48,50
963.8256	10	22,0	25,0	40,0	80	52,50
963.8257	12	24,0	25,0	40,0	90	57,90
963.8258	16	30,0	25,0	50,0	150	72,90
963.8259	20	37,0	28,0	50,0	220	88,90
963.8260	25	44,0	32,0	60,0	400	133,90

NON SPARKING TOOLS

BRONZEplus socket

- 3-point
- In accordance to DIN 22417
- With pushed through, movable drive handle
- Non-sparking
- Explosion proof
- Corrosion resistant
- Wear resistant
- Aluminium-Bronze (Non-Ferrous-Alloy)

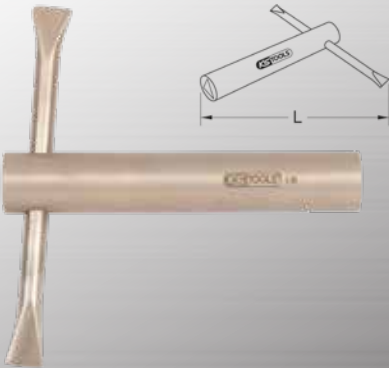

	mm	L mm	kg	€
963.8261	4	95,0	0,08	57,90
963.8262	5	110,0	0,10	57,90
963.8263	6	115,0	0,17	64,50
963.8264	8	125,0	0,28	75,90
963.8265	10	140,0	0,39	90,90
963.8266	12	160,0	0,70	112,50
963.8267	16	180,0	0,98	151,90
963.8268	20	200,0	2,10	211,90
963.8269	24	220,0	3,10	302,90

	mm	L mm		kg	€
963.8301	35	530,0	7	3,30	448,50
963.8302	36	530,0	7	3,30	448,50
963.8303	37	530,0	7	3,30	448,50
963.8304	38	530,0	7	3,30	448,50
963.8305	41	580,0	8	4,00	539,50
963.8306	42	580,0	8	4,00	539,50
963.8307	46	635,0	8	4,80	593,90
963.8308	47	635,0	8	4,80	593,90
963.8309	50	320,0	9,10	4,90	696,50
963.8310	52	320,0	9,10	4,90	696,50
963.8311	54	340,0	9,10	6,50	836,90
963.8312	55	340,0	9,10	6,50	836,90
963.8313	56	340,0	9,10	6,50	836,90
963.8314	58	360,0	9,10	8,30	878,50
963.8315	60	360,0	9,10	8,30	1036,90
963.8316	63	360,0	9,10	8,30	1036,90
963.8317	65	380,0	11	10,50	1271,50
963.8318	67	380,0	11	10,50	1271,50
963.8319	70	380,0	11	10,50	1271,50
963.8320	71	380,0	11	10,50	1271,50
963.8321	75	400,0	11	14,30	1453,50
963.8322	77	400,0	11	14,30	1453,50
963.8323	80	400,0	11	14,30	1453,50
963.8324	82	400,0	11	14,30	1998,90
963.8325	85	425,0	12	19,20	1998,90
963.8326	88	425,0	12	19,20	1998,90
963.8327	90	425,0	12	19,20	1998,90
963.8328	94	455,0	12	26,00	2665,50
963.8329	95	455,0	12	26,00	2665,50
963.8330	100	455,0	12	26,00	2665,50

BRONZEplus Tommy bar for box spanner

- Non-sparking
- Explosion proof
- Corrosion resistant
- Wear resistant
- Aluminium-Bronze (Non-Ferrous-Alloy)



	mm	D mm	L mm	#	kg	€
963.8331	10	6,0	150,0	1	0,04	18,50
963.8332	12	8,0	190,0	2	0,10	21,50
963.8333	16	10,0	190,0	3	0,09	21,50
963.8334	22	10,0	250,0	4	0,18	36,50
963.8335	27	12,0	315,0	5	0,31	46,50
963.8336	34	16,0	400,0	6	0,60	64,50
963.8337	38	16,0	500,0	7	0,92	90,90
963.8338	47	20,0	630,0	8	1,60	145,50
963.8339	63	24,0	800,0	9	2,70	291,50
963.8340	63	24,0	1000,0	10	3,50	339,50
963.8341	82	30,0	1250,0	11	6,00	684,90
963.8342	100	36,0	1600,0	12	12,00	1332,50

BRONZEplus box spanner, offset

- 6 point
- Non-sparking
- Explosion proof
- Corrosion resistant
- Wear resistant
- Aluminium-Bronze (Non-Ferrous-Alloy)

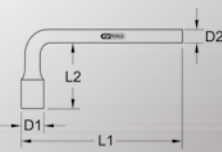

	mm	D1 mm	D2 mm	L1 mm	L2 mm	kg	€
963.8343	8	16,0	8,0	175,0	30,0	0,10	42,90
963.8344	9	17,0	8,0	185,0	33,0	0,12	46,50

	mm	D1 mm	D2 mm	L1 mm	L2 mm	kg	€
963.8345	10	18,0	8,0	195,0	37,0	0,14	52,50
963.8346	11	20,0	9,0	205,0	42,0	0,18	57,90
963.8347	12	21,0	9,0	220,0	42,0	0,22	57,90
963.8348	13	22,0	10,0	240,0	45,0	0,28	60,90
963.8349	14	22,0	10,0	240,0	45,0	0,28	66,50
963.8350	15	25,0	11,0	250,0	48,0	0,30	72,90
963.8351	16	25,0	11,0	250,0	48,0	0,30	82,50
963.8352	17	27,0	12,0	270,0	51,0	0,32	90,90
963.8353	18	27,0	12,0	270,0	53,0	0,32	106,90
963.8354	19	30,0	12,0	290,0	55,0	0,53	112,50
963.8355	20	30,0	12,0	290,0	57,0	0,53	120,90
963.8356	21	32,0	12,0	310,0	57,0	0,68	139,50
963.8357	22	32,0	12,0	310,0	59,0	0,68	145,50
963.8358	23	35,0	14,0	335,0	63,0	0,83	170,50
963.8359	24	35,0	14,0	335,0	63,0	0,83	170,50
963.8360	25	39,0	14,0	365,0	69,0	1,00	205,50
963.8361	26	39,0	14,0	365,0	69,0	1,00	205,50
963.8362	27	39,0	14,0	365,0	69,0	1,00	205,50
963.8363	28	43,0	15,0	395,0	72,0	1,30	223,90
963.8364	29	43,0	15,0	395,0	72,0	1,30	223,90
963.8365	30	43,0	15,0	395,0	72,0	1,30	223,90
963.8366	32	47,0	16,0	425,0	75,0	1,70	278,50
963.8367	33	47,0	16,0	425,0	75,0	1,70	284,90
963.8368	34	47,0	18,0	425,0	75,0	1,70	284,90
963.8369	35	52,0	18,0	465,0	80,0	2,80	320,90
963.8370	36	52,0	18,0	465,0	80,0	2,80	327,50
963.8371	37	52,0	18,0	465,0	80,0	2,80	327,50
963.8372	38	52,0	18,0	465,0	80,0	2,80	327,50
963.8373	41	58,0	20,0	510,0	85,0	3,60	441,90
963.8374	42	58,0	20,0	510,0	85,0	3,60	441,90
963.8375	46	65,0	21,0	555,0	90,0	4,00	514,90
963.8376	47	65,0	21,0	555,0	90,0	4,00	514,90
963.8377	50	72,0	22,0	605,0	93,0	4,80	545,90
963.8378	52	72,0	22,0	605,0	93,0	4,80	545,90
963.8379	54	76,0	24,0	660,0	97,0	6,40	654,90
963.8380	55	76,0	24,0	660,0	97,0	6,40	654,90
963.8381	56	76,0	24,0	660,0	97,0	6,40	654,90
963.8382	58	84,0	25,0	730,0	103,0	8,20	684,90
963.8383	60	84,0	25,0	730,0	103,0	8,20	903,50
963.8384	63	89,0	25,0	730,0	103,0	8,20	903,50
963.8385	65	89,0	27,0	800,0	108,0	10,40	1127,90
963.8386	67	95,0	27,0	800,0	108,0	10,40	1127,90
963.8387	70	95,0	27,0	800,0	115,0	10,40	1127,90
963.8388	71	95,0	27,0	800,0	115,0	10,40	1127,90
963.8389	75	105,0	30,0	880,0	120,0	14,10	1332,50
963.8390	77	105,0	30,0	880,0	120,0	14,10	1332,50
963.8391	80	112,0	30,0	880,0	125,0	14,10	1332,50
963.8392	82	112,0	30,0	880,0	125,0	14,10	1453,50

BRONZEplus box spanner, double sided

- 6 point
- For use with open ended spanner or tommy bar
- Non-sparking
- Explosion proof
- Corrosion resistant
- Wear resistant
- Aluminium-Bronze (Non-Ferrous-Alloy)

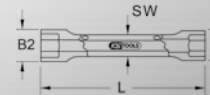

	mm	B1 mm	B2 mm	mm	L mm	kg	€	
963.8393	7x8	14,0	15,0	10	95,0	1	0,05	88,90
963.8394	9x10	16,0	18,0	10	105,0	2	0,07	97,50
963.8395	10x11	18,0	19,0	14	120,0	2	0,18	102,90
963.8396	12x14	21,0	22,0	17	135,0	3	0,16	112,50
963.8397	14x17	24,0	27,0	17	150,0	3	0,36	118,90
963.8398	17x19	27,0	30,0	19	160,0	4	0,28	127,50
963.8399	19x22	30,0	32,0	22	170,0	4	0,58	139,50
963.8400	20x22	32,0	39,0	22	170,0	4	0,58	145,50
963.8401	24x26	35,0	39,0	24	180,0	5	0,48	181,90
963.8402	24x27	35,0	39,0	24	190,0	5	0,53	188,50
963.8403	27x32	39,0	47,0	27	200,0	6	0,87	200,50
963.8404	30x32	43,0	47,0	27	210,0	6	0,89	211,90
963.8405	30x36	43,0	52,0	30	220,0	6	1,08	236,50
963.8406	36x41	52,0	58,0	32	230,0	6	1,70	272,90

BRONZEplus Tommy bar for box spanner

- Non-sparking
- Explosion proof
- Corrosion resistant
- Wear resistant
- Aluminium-Bronze (Non-Ferrous-Alloy)



	D mm	L mm	mm	#	kg	€
963.8407	5,0	110,0	7x8	1	20	16,50
963.8408	6,0	150,0	10x11	2	40	16,50
963.8409	10,0	220,0	14x17	3	120	24,90
963.8410	12,0	300,0	20x22	4	300	27,90
963.8411	15,0	390,0	24x27	5	480	46,50
963.8412	16,0	500,0	36x41	6	750	75,90

BRONZEplus Hexagonal socket spanner firm sliding bar

- 6 point
- With fixed drive handle
- Non-sparking
- Explosion proof
- Corrosion resistant
- Wear resistant
- Aluminium-Bronze (Non-Ferrous-Alloy)

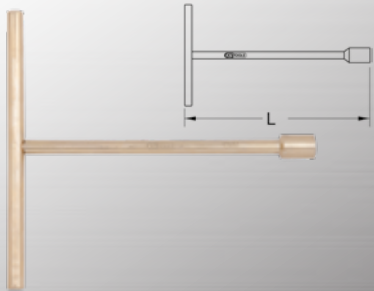

	mm	L mm	kg	€
963.8413	8	196,0	0,14	60,90
963.8414	9	209,0	0,25	72,90
963.8415	10	223,0	0,19	82,50
963.8416	11	240,0	0,26	112,50
963.8417	12	256,0	0,31	127,50
963.8418	13	275,0	0,41	139,50
963.8419	14	275,0	0,41	145,50
963.8420	15	292,0	0,40	157,50
963.8421	16	292,0	0,45	170,50
963.8422	17	314,0	0,50	181,90
963.8423	18	314,0	0,55	181,90
963.8424	19	339,0	0,55	205,50
963.8425	20	339,0	0,55	211,90
963.8426	21	376,0	1,05	223,90
963.8427	22	376,0	1,05	223,90
963.8428	23	393,0	1,24	254,90
963.8429	24	393,0	1,24	254,90
963.8430	25	431,0	1,70	278,50
963.8431	26	431,0	1,70	278,50
963.8432	27	431,0	1,70	291,50
963.8433	28	464,0	2,10	302,90
963.8434	29	464,0	2,10	327,50
963.8435	30	464,0	2,10	327,50
963.8436	32	506,0	2,75	369,50
963.8437	33	506,0	2,75	369,50
963.8438	34	506,0	2,75	369,50
963.8439	35	550,0	4,00	436,50
963.8440	36	550,0	4,00	436,50
963.8441	37	550,0	4,00	436,50
963.8442	38	550,0	4,00	436,50
963.8443	41	600,0	5,40	527,50
963.8444	42	600,0	5,40	527,50
963.8445	46	655,0	6,00	630,50
963.8446	47	655,0	6,00	630,50
963.8447	50	345,0	6,30	732,90
963.8448	52	345,0	6,30	732,90
963.8449	54	365,0	8,00	823,90
963.8450	55	365,0	8,00	823,90
963.8451	56	365,0	8,00	823,90

	mm	L mm	kg	€
963.8452	58	390,0	10,50	1103,50
963.8453	60	390,0	10,50	1103,50
963.8454	63	390,0	10,50	1103,50
963.8455	65	410,0	14,00	1271,50
963.8456	67	410,0	14,00	1271,50
963.8457	70	410,0	14,00	1271,50
963.8458	71	410,0	14,00	1271,50
963.8459	75	430,0	19,00	1453,50
963.8460	77	430,0	19,00	1453,50
963.8461	80	430,0	19,00	1453,50
963.8462	82	430,0	19,00	1998,90

BERYLLIUMplus socket screwdriver

- 6 point
- Two component handle
- Optimal power transmission
- Non-sparking
- Explosion proof
- Corrosion resistant
- Very breakage resistant
- Copper Beryllium (Non-Ferrous-Alloy)

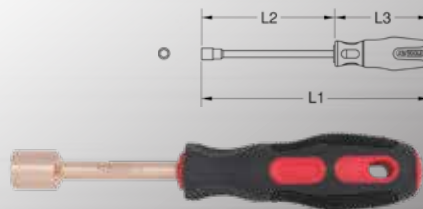

	mm	L1 mm	L2 mm	L3 mm	kg	€
962.0970	3,5	175,0	75,0	100,0	80	46,50
962.0971	4,5	180,0	80,0	100,0	80	54,50
962.0972	5	180,0	80,0	100,0	60	57,90
962.0973	5,5	185,0	85,0	100,0	60	60,90
962.0974	6	190,0	90,0	100,0	80	60,90
962.0975	6,5	190,0	90,0	100,0	90	70,90
962.0976	7	190,0	90,0	100,0	80	70,90
962.0977	7,5	200,0	100,0	100,0	80	79,50
962.0978	8	200,0	100,0	100,0	100	90,90
962.0979	9	210,0	110,0	100,0	100	90,90
962.0980	10	210,0	110,0	100,0	150	90,90
962.0981	11	220,0	110,0	110,0	150	90,90
962.0982	12	220,0	110,0	110,0	130	112,50
962.0983	13	230,0	120,0	110,0	170	112,50
962.0984	14	230,0	120,0	110,0	210	127,50
962.0985	15	240,0	130,0	110,0	210	127,50
962.0986	16	240,0	130,0	110,0	260	127,50
962.0987	17	250,0	130,0	120,0	280	127,50



		L1 mm	L2 mm	L3 mm	kg	€
962.0988	1/8"	175,0	75,0	100,0	10	46,50
962.0989	5/32"	180,0	80,0	100,0	70	46,50
962.0990	3/16"	185,0	85,0	100,0	60	57,90
962.0991	7/32"	190,0	90,0	100,0	80	60,90
962.0992	1/4"	190,0	90,0	100,0	80	70,90
962.0993	5/16"	210,0	100,0	110,0	100	90,90
962.0994	3/8"	220,0	110,0	110,0	100	90,90
962.0995	7/16"	230,0	120,0	110,0	170	90,90
962.0996	1/2"	230,0	120,0	110,0	210	112,50
962.0997	9/16"	240,0	120,0	120,0	120	127,50
962.0998	5/8"	250,0	130,0	120,0	150	127,50
962.0999	11/16"	250,0	130,0	120,0	240	127,50

BRONZEplus Pronged wrench

- Light work in inaccessible places
- For use with tommy bar
- Jaw 90° offset
- Non-sparking
- Explosion proof
- Corrosion resistant
- Wear resistant
- Aluminium-Bronze (Non-Ferrous-Alloy)

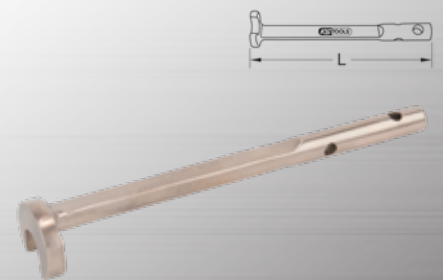

	mm	L mm		kg	€
963.8463	13	160,0	1	0,10	94,50
963.8464	14	160,0	1	0,10	94,50
963.8465	15	200,0	1	0,17	109,50
963.8466	16	200,0	2	0,17	127,50
963.8467	17	200,0	2	0,17	133,90
963.8468	18	200,0	2	0,19	133,90
963.8469	19	200,0	3	0,22	170,50
963.8470	20	200,0	3	0,25	170,50
963.8471	21	200,0	3	0,26	170,50
963.8472	22	200,0	3	0,30	170,50
963.8473	23	200,0	4	0,35	205,50
963.8474	24	250,0	4	0,40	205,50
963.8475	25	250,0	4	0,40	205,50
963.8476	26	250,0	4	0,45	205,50
963.8477	27	250,0	4	0,45	205,50
963.8478	28	250,0	5	0,50	236,50
963.8479	29	250,0	5	0,55	236,50
963.8480	30	250,0	5	0,60	230,50
963.8481	32	250,0	5	0,65	236,50
963.8482	36	250,0	6	0,70	278,50
963.8483	41	315,0	6	1,15	278,50
963.8484	46	315,0	7	1,23	339,50
963.8485	50	315,0	7	1,50	339,50

BRONZEplus Tommy bar for pronged wrench

- Non-sparking
- Explosion proof
- Corrosion resistant
- Wear resistant
- Aluminium-Bronze (Non-Ferrous-Alloy)



	mm	D mm	L mm	#	kg	€
963.8486	13-15	8,0	160,0	1	0,07	21,50
963.8487	16-18	10,0	200,0	2	0,13	24,90
963.8488	19-22	12,0	200,0	3	0,22	36,50
963.8489	23-27	14,0	250,0	4	0,40	46,50
963.8490	28-32	16,0	250,0	5	0,60	46,50
963.8491	36-41	18,0	315,0	6	1,00	66,50
963.8492	46-50	20,0	315,0	7	1,60	70,90

BRONZEplus Crowfoot wrench, hexagonal

- 6 point
- Internal square drive
- For manual operation
- Non-sparking
- Explosion proof
- Corrosion resistant
- Wear resistant
- Aluminium-Bronze (Non-Ferrous-Alloy)

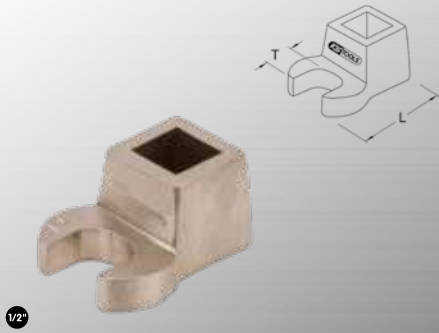

	mm	L mm	T mm	g	€
963.8493	13	40,0	15,0	50	46,50
963.8494	14	40,0	15,0	50	46,50
963.8495	15	43,0	20,0	80	46,50
963.8496	16	43,0	20,0	80	46,50
963.8497	17	43,0	20,0	80	57,90
963.8498	18	49,0	22,0	110	57,90
963.8499	19	49,0	22,0	120	57,90
963.8500	20	49,0	22,0	130	57,90
963.8501	21	52,0	26,0	150	60,90
963.8502	22	52,0	26,0	170	60,90
963.8503	23	52,0	29,0	200	70,90
963.8504	24	55,0	29,0	200	70,90
963.8505	25	55,0	32,0	220	72,90
963.8506	26	59,0	32,0	220	72,90
963.8507	27	59,0	32,0	250	72,90
963.8508	28	59,0	32,0	270	90,90
963.8509	29	63,0	34,0	300	90,90
963.8510	30	63,0	34,0	320	112,50
963.8511	32	67,0	37,0	350	118,90
963.8512	36	76,0	42,0	570	151,90
963.8513	41	86,0	48,0	620	175,50
963.8514	46	97,0	55,0	750	200,50
963.8515	50	105,0	60,0	800	205,50



BRONZEplus Special extender for crowfoot spanner

- Non-sparking
- Explosion proof
- Corrosion resistant
- Wear resistant
- Aluminium-Bronze (Non-Ferrous-Alloy)

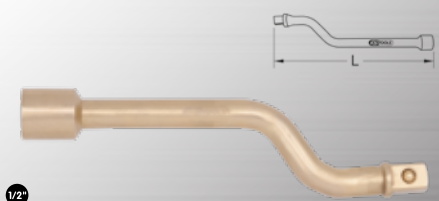

	□	L mm	g	€
963.8516	1/2	150,0	200	170,50
963.8517	1/2	250,0	400	200,50

NON SPARKING FRICTION RATCHETS

BRONZEplus Construction ratchet

- 6 point
- With centring point
- Non-sparking
- Explosion proof
- Corrosion resistant
- Wear resistant
- Aluminium-Bronze (Non-Ferrous-Alloy)

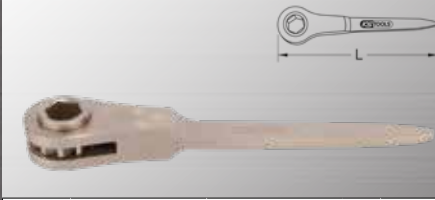

	mm	L mm	g	€
963.1105	17	230,0	0,62	112,50
963.1106	19	240,0	0,65	133,90
963.1107	21	250,0	0,83	145,50
963.1108	22	260,0	0,83	145,50
963.1109	24	270,0	1,02	170,50
963.1110	26	280,0	1,05	170,50
963.1111	27	285,0	1,10	170,50
963.1112	30	300,0	1,32	211,90
963.1113	32	315,0	1,10	223,90
963.1114	35	325,0	1,63	248,50
963.1115	36	330,0	1,67	266,50
963.1116	41	330,0	1,95	291,50

BERYLLIUMplus Friction ratchet

- 12 point
- Non-sparking
- Explosion proof
- Corrosion resistant
- Very breakage resistant
- Aluminium-Bronze (Non-Ferrous-Alloy)



	mm	L mm	g	€
962.0109	9	150,0	0,15	118,90
962.0111	11	150,0	0,15	127,50
962.0113	13	155,0	0,16	145,50
962.0114	14	155,0	0,16	151,90
962.0117	17	200,0	0,26	157,50
962.0119	19	200,0	0,26	175,50
962.0122	22	220,0	0,34	200,50
962.0124	24	220,0	0,34	211,90
962.0127	27	245,0	0,56	236,50
962.0130	30	280,0	0,84	260,50
962.0132	32	280,0	0,84	302,90
962.0136	36	290,0	1,18	339,50
962.0141	41	295,0	1,23	369,50
962.0146	46	360,0	2,06	521,50
962.0150	50	360,0	2,23	587,50
962.0155	55	440,0	2,90	641,90
962.0160	60	440,0	2,90	684,90



1/4" DRIVE NON SPARKING SOCKETS

BERYLLIUMplus socket

- 6 point
- In accordance to DIN 3124 / ISO 2725-1
- Internal square to DIN 3120 / ISO 1174 with ball reception
- Non-sparking
- Explosion proof
- Corrosion resistant
- Very breakage resistant
- Copper Beryllium (Non-Ferrous-Alloy)



	mm	D1 mm	D2 mm	L mm	g	€
962.1404	4,0	10,0	15,0	25,0	10	34,50
962.14045	4,5	10,0	15,0	25,0	10	34,50
962.1405	5,0	11,0	15,0	25,0	10	34,50
962.14055	5,5	11,0	15,0	25,0	10	34,50
962.1406	6,0	12,0	15,0	25,0	10	36,50
962.1407	7,0	13,0	15,0	25,0	10	42,90
962.1408	8,0	14,0	15,0	25,0	20	42,90
962.1409	9,0	15,0	15,0	25,0	20	42,90
962.1410	10,0	16,0	15,0	25,0	20	52,50
962.1411	11,0	18,0	15,0	25,0	20	57,90
962.1412	12,0	19,0	15,0	27,0	30	57,90
962.1413	13,0	20,0	15,0	27,0	30	60,90
962.1414	14,0	22,0	15,0	27,0	30	66,50

BERYLLIUMplus reversible ratchet

- In accordance to DIN 3122 / ISO 3315
- Square drive to DIN 3120 / ISO 1174 with ball lock
- Reversible
- Gearing with 45 teeth
- Non-sparking
- Explosion proof
- Corrosion resistant
- Very breakage resistant
- Copper Beryllium (Non-Ferrous-Alloy)

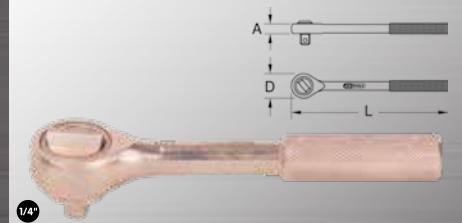

	□	A mm	D mm	L mm	g	€
962.1490	1/4"	15,0	30,0	150,0	200	163,90

BERYLLIUMplus Ratchet handle with coupler

- Square drive to DIN 3120 / ISO 1174 with ball lock
- The direction of rotation (clockwise and counter clockwise) can be changed by simply rotating the square drive piece
- Non-sparking
- Explosion proof
- Corrosion resistant
- Very breakage resistant
- Copper Beryllium (Non-Ferrous-Alloy)

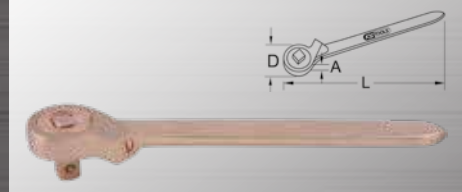

	□	A mm	D mm	L mm	g	€
962.1491	1/4"	14,0	36,0	150,0	320	157,50

BERYLLIUMplus Coupler

- Non-sparking
- Explosion proof
- Corrosion resistant
- Very breakage resistant
- Copper Beryllium (Non-Ferrous-Alloy)



	1/4"	L mm	g	€
962.1475	1/4"	25,0	10	70,90

BERYLLIUMplus Extension

- Square drive to DIN 3120 / ISO 1174 with ball lock
- Internal square to DIN 3120 / ISO 1174 with ball reception
- Non-sparking
- Explosion proof
- Corrosion resistant
- Very breakage resistant
- Copper Beryllium (Non-Ferrous-Alloy)

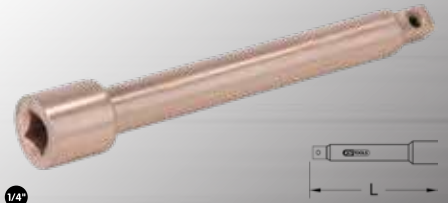

	1/4"	L mm	g	€
962.1450	1/4"	55,0	20	46,50
962.1451	1/4"	100,0	60	84,50
962.1452	1/4"	200,0	100	106,90

BERYLLIUMplus Swivel handle

- Square drive to DIN 3120 / ISO 1174 with ball lock
- Non-sparking
- Explosion proof
- Corrosion resistant
- Very breakage resistant
- Copper Beryllium (Non-Ferrous-Alloy)

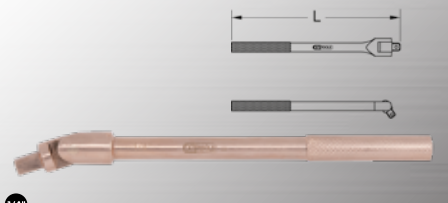

	1/4"	L mm	g	€
962.1455	1/4"	165,0	160	118,90
962.1456	1/4"	215,0	350	151,90

BERYLLIUMplus sliding T-handle

- In accordance to DIN 3122 / ISO 3315
- Square drive to DIN 3120 / ISO 1174 with ball lock
- Non-sparking
- Explosion proof
- Corrosion resistant
- Very breakage resistant
- Copper Beryllium (Non-Ferrous-Alloy)

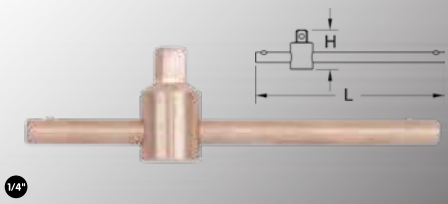

	1/4"	H mm	L mm	g	€
962.1460	1/4"	28,0	200,0	160	151,90

BERYLLIUMplus Square drive screwdriver

- Square drive to DIN 3120 / ISO 1174 with ball lock
- Non-sparking
- Explosion proof
- Corrosion resistant
- Very breakage resistant
- Copper Beryllium (Non-Ferrous-Alloy)



	1/4"	L1 mm	L2 mm	L3 mm	g	€
962.1465	1/4"	140,0	55,0	85,0	90	75,90

BERYLLIUMplus adaptor and reducing adaptor

- In accordance to DIN 3123 / ISO 3316
- Square drive to DIN 3120 / ISO 1174 with ball lock
- Internal square to DIN 3120 / ISO 1174 with ball reception
- Non-sparking
- Explosion proof
- Corrosion resistant
- Very breakage resistant
- Copper Beryllium (Non-Ferrous-Alloy)



	1/4"	1/2"	L mm	g	€
962.1470	1/4"	1/2"	30,0	40	70,90
962.1280	1/2"	1/4"	40,0	60	72,90

BERYLLIUMplus universal joint

- In accordance to DIN 3123 / ISO 3316
- Square drive to DIN 3120 / ISO 1174 with ball lock
- Internal square to DIN 3120 / ISO 1174 with ball reception
- Non-sparking
- Explosion proof
- Corrosion resistant
- Very breakage resistant
- Copper Beryllium (Non-Ferrous-Alloy)



	1/4"	1/4"	L mm	g	€
962.1480	1/4"	1/4"	55,0	70	120,90

BERYLLIUMplus Socket set

- Non-sparking
- Explosion proof
- Corrosion resistant
- Very breakage resistant
- Copper Beryllium (Non-Ferrous-Alloy)
- In durable plastic storage case



	1/4"	g	€
962.1485	15 pcs BERYLLIUMplus Socket set	1000	939,50
13 x	4 - 4,5 - 5 - 5,5 - 6 - 7 - 8 - 9 - 10 - 11 - 12 - 13 - 14 mm		
1 x	100 mm		
1 x	250 mm		

1/2" DRIVE NON SPARKING SOCKETS

BRONZEplus socket

- 6 point
- In accordance to DIN 3124 / ISO 2725-1
- Internal square to DIN 3120 / ISO 1174 with ball reception
- Non-sparking
- Explosion proof
- Corrosion resistant
- Wear resistant
- Aluminium-Bronze (Non-Ferrous-Alloy)



	1/2"	mm	D1 mm	D2 mm	L mm	g	€
963.1204	6	14,0	24,0	40,0	70	39,50	
963.1205	7	14,0	24,0	40,0	80	39,50	
963.1206	8	15,0	24,0	40,0	50	39,50	
963.1207	9	16,0	24,0	40,0	50	39,50	
963.1208	10	17,0	24,0	40,0	50	39,50	
963.1209	11	19,0	24,0	40,0	50	39,50	
963.1210	12	20,0	24,0	40,0	50	39,50	
963.1211	13	20,0	24,0	40,0	50	39,50	
963.1212	14	24,0	24,0	40,0	80	39,50	
963.1213	15	25,0	25,0	40,0	90	39,50	
963.1214	16	25,0	25,0	40,0	60	42,90	
963.1215	17	26,0	26,0	40,0	90	42,90	
963.1216	18	29,0	27,0	40,0	120	72,90	
963.1217	19	30,0	28,0	40,0	130	72,90	
963.1218	20	31,0	28,0	40,0	130	72,90	
963.1219	21	32,0	28,0	40,0	100	72,90	
963.1220	22	33,0	28,0	40,0	110	72,90	
963.1221	23	34,0	31,0	40,0	120	72,90	
963.1222	24	35,0	31,0	40,0	150	72,90	
963.1223	25	36,0	32,0	40,0	130	72,90	
963.1224	26	37,0	34,0	40,0	180	72,90	
963.1225	27	38,0	34,0	40,0	150	72,90	
963.1226	28	40,0	36,0	40,0	200	79,50	
963.1227	29	42,0	36,0	40,0	220	84,50	
963.1228	30	43,0	40,0	40,0	250	84,50	
963.1229	32	45,0	42,0	42,0	240	90,90	
963.1230	34	48,0	42,0	50,0	300	133,90	
963.1231	36	50,0	42,0	50,0	380	139,50	
963.1341	41	57,0	44,0	50,0	560	157,50	

	1/2"	D1 mm	D2 mm	L mm	g	€
963.1249	1/4"	15,0	24,0	40,0	50	42,90
963.1250	5/16"	15,0	24,0	40,0	50	46,50
963.1251	11/32"	16,0	24,0	40,0	50	46,50
963.1252	3/8"	17,0	24,0	40,0	50	52,50
963.1253	13/32"	18,0	24,0	40,0	50	52,50
963.1254	7/16"	19,0	24,0	40,0	50	52,50
963.1255	1/2"	21,0	24,0	40,0	50	52,50
963.1256	9/16"	23,0	24,0	40,0	80	52,50
963.1257	19/32"	24,0	24,0	40,0	90	57,90
963.1258	5/8"	26,0	26,0	40,0	60	64,50
963.1259	11/16"	28,0	26,0	40,0	90	64,50
963.1260	3/4"	29,0	26,0	40,0	130	70,90
963.1261	25/32"	31,0	26,0	40,0	130	79,50
963.1262	13/16"	32,0	26,0	40,0	130	79,50
963.1263	7/8"	33,0	28,0	40,0	110	84,50
963.1264	15/16"	35,0	31,0	40,0	120	84,50
963.1265	1"	36,0	34,0	40,0	130	100,50
963.1266	1.1/16"	39,0	34,0	40,0	150	102,90
963.1267	1.1/8"	41,0	36,0	40,0	220	106,90
963.1268	1.3/16"	43,0	40,0	40,0	250	112,50
963.1269	1.1/4"	45,0	42,0	42,0	240	112,50



BRONZEplus socket, long

- 6 point
- In accordance to DIN 3124 / ISO 2725-1
- Internal square to DIN 3120 / ISO 1174 with ball reception
- Non-sparking
- Explosion proof
- Corrosion resistant
- Wear resistant
- Aluminium-Bronze (Non-Ferrous-Alloy)



	mm	D1 mm	D2 mm	L mm	g	€
963.1232	10	19,0	25,0	77,0	110	57,90
963.1233	12	20,0	25,0	77,0	170	57,90
963.1234	13	21,0	25,0	77,0	170	57,90
963.1235	14	22,0	25,0	77,0	110	57,90
963.1236	15	25,0	25,0	77,0	120	64,50
963.1237	16	25,0	25,0	77,0	170	64,50
963.1238	17	27,0	27,0	77,0	140	84,50
963.1239	18	28,0	28,0	82,0	250	106,90
963.1240	19	30,0	28,0	82,0	180	106,90
963.1241	21	32,0	28,0	82,0	260	106,90
963.1242	22	33,0	28,0	82,0	210	118,90
963.1243	24	36,0	30,0	82,0	250	118,90
963.1244	27	40,0	30,0	82,0	400	163,90
963.1245	30	44,0	32,0	82,0	510	193,90
963.1246	32	46,0	32,0	82,0	550	193,90
963.1247	34	48,0	34,0	82,0	710	211,90
963.1248	36	50,0	34,0	82,0	760	236,50

BERYLLIUMplus reversible ratchet

- In accordance to DIN 3122 / ISO 3315
- Square drive to DIN 3120 / ISO 1174 with ball lock
- Reversible
- Gearing with 45 teeth
- Non-sparking
- Explosion proof
- Corrosion resistant
- Very breakage resistant
- Copper Beryllium (Non-Ferrous-Alloy)

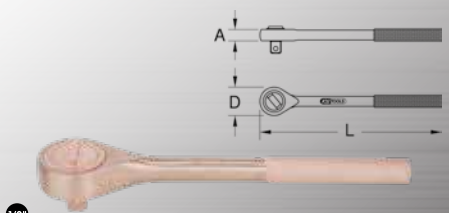

	A mm	D mm	L mm	g	€	
962.1290	1/2"	23,0	54,0	250,0	590	291,50

BERYLLIUMplus Ratchet handle with coupler

- Square drive to DIN 3120 / ISO 1174 with ball lock
- The direction of rotation (clockwise and counter clockwise) can be changed by simply rotating the square drive piece
- Non-sparking
- Explosion proof
- Corrosion resistant
- Very breakage resistant
- Copper Beryllium (Non-Ferrous-Alloy)



	A mm	D mm	L mm	g	€	
962.1291	1/2"	17,0	45,0	250,0	430	327,50

BRONZEplus Coupler

- Square drive to DIN 3120 / ISO 1174 with ball lock
- Non-sparking
- Explosion proof
- Corrosion resistant
- Wear resistant
- Aluminium-Bronze (Non-Ferrous-Alloy)



	mm	L mm	g	€
963.1281	1/2"	36,5	50	39,50

BRONZEplus extension

- In accordance to DIN 3123 / ISO 3316
- Square drive to DIN 3120 / ISO 1174 with ball lock
- Internal square to DIN 3120 / ISO 1174 with ball reception
- Non-sparking
- Explosion proof
- Corrosion resistant
- Wear resistant
- Aluminium-Bronze (Non-Ferrous-Alloy)



	L mm	g	€	
963.1270	1/2"	100,0	180	72,90
963.1271	1/2"	200,0	270	112,50
963.1272	1/2"	250,0	360	133,90

BRONZEplus flexi drive handle

- In accordance to DIN 3122 / ISO 3315
- Square drive to DIN 3120 / ISO 1174 with ball lock
- Non-sparking
- Explosion proof
- Corrosion resistant
- Wear resistant
- Aluminium-Bronze (Non-Ferrous-Alloy)

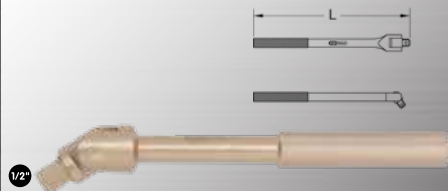

	L mm	g	€	
963.1273	1/2"	215,0	350	157,50
963.1274	1/2"	250,0	560	181,90
963.1275	1/2"	300,0	920	223,90
963.1276	1/2"	380,0	590	266,50

BRONZEplus sliding T-handle

- In accordance to DIN 3122 / ISO 3315
- Square drive to DIN 3120 / ISO 1174 with ball lock
- Non-sparking
- Explosion proof
- Corrosion resistant
- Wear resistant
- Aluminium-Bronze (Non-Ferrous-Alloy)



	H mm	L mm	g	€	
963.1277	1/2"	46,0	250,0	450	84,50
963.1278	1/2"	46,0	320,0	550	90,90

BRONZEplus adaptor and reducing adaptor

- In accordance to DIN 3123 / ISO 3316
- Square drive to DIN 3120 / ISO 1174 with ball lock
- Internal square to DIN 3120 / ISO 1174 with ball reception
- Non-sparking
- Explosion proof
- Corrosion resistant
- Wear resistant
- Aluminium-Bronze (Non-Ferrous-Alloy)

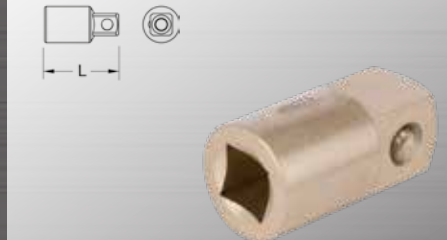

	mm	L mm	g	€	
963.1279	1/2"	3/4"	22,0	120	60,90
963.1280	1/2"	1/4"	40,0	60	72,90

BRONZEplus universal joint

- In accordance to DIN 3123 / ISO 3316
- Square drive to DIN 3120 / ISO 1174 with ball lock
- Internal square to DIN 3120 / ISO 1174 with ball reception
- Non-sparking
- Explosion proof
- Corrosion resistant
- Wear resistant
- Aluminium-Bronze (Non-Ferrous-Alloy)



	L mm	g	€		
963.1282	1/2"	1/2"	70,0	170	100,50

BRONZEplus L-Handle

- In accordance to DIN ISO 2936
- Square drive to DIN 3120 / ISO 1174 with ball lock
- Non-sparking
- Explosion proof
- Corrosion resistant
- Wear resistant
- Aluminium-Bronze (Non-Ferrous-Alloy)

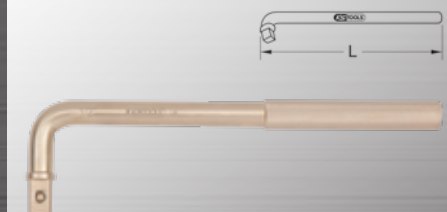

	L mm	g	€	
963.1283	1/2"	220,0	260	88,90
963.1284	1/2"	260,0	400	100,50

BRONZEplus Speed brace

- Square drive to DIN 3120 / ISO 1174 with ball lock
- Non-sparking
- Explosion proof
- Corrosion resistant
- Wear resistant
- Aluminium-Bronze (Non-Ferrous-Alloy)

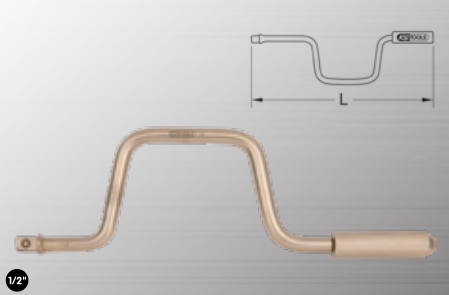

	1/2"	L mm	g	€
963.1285	1/2"	410,0	700	139,50

BRONZEplus Bit socket for slotted screws

- Slotted
- Internal square to DIN 3120 / ISO 1174 with ball reception
- Non-sparking
- Explosion proof
- Corrosion resistant
- Wear resistant
- Aluminium-Bronze (Non-Ferrous-Alloy)

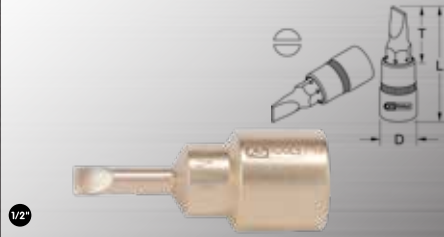

	mm	D mm	L mm	T mm	g	€
963.1292	4,0	25,0	60,0	9,0	140	57,90
963.1293	6,0	25,0	60,0	9,0	140	60,90
963.1294	8,0	25,0	60,0	9,0	140	79,50
963.1295	10,0	25,0	60,0	9,0	140	106,90

BRONZEplus Bit socket for hexagon screws, long

- Hexagon socket
- In accordance with DIN 7422
- Internal square drive to DIN 3120 / ISO 1174 with ball reception
- Non-sparking
- Explosion proof
- Corrosion resistant
- Wear resistant
- Aluminium-Bronze (Non-Ferrous-Alloy)

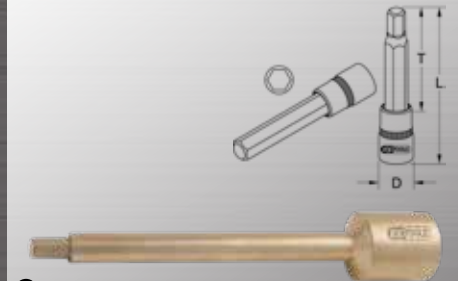

	mm	D mm	L mm	T mm	g	€
963.1311	5	25,0	90,0	12,0	90	64,50
963.1312	5	25,0	180,0	12,0	100	70,90
963.1313	6	25,0	90,0	12,0	80	70,90
963.1314	6	25,0	140,0	12,0	120	70,90
963.1315	6	25,0	160,0	12,0	130	70,90
963.1316	7	25,0	100,0	12,0	90	66,50
963.1317	8	25,0	90,0	12,0	90	66,50
963.1318	8	25,0	120,0	12,0	160	72,90
963.1319	10	25,0	140,0	12,0	150	75,90
963.1320	12	25,0	140,0	12,0	190	82,50
963.1321	14	25,0	140,0	12,0	250	82,50

BRONZEplus T-handle

- In accordance to DIN 3122 / ISO 3315
- Square drive to DIN 3120 / ISO 1174 with ball lock
- Non-sparking
- Explosion proof
- Corrosion resistant
- Wear resistant
- Aluminium-Bronze (Non-Ferrous-Alloy)

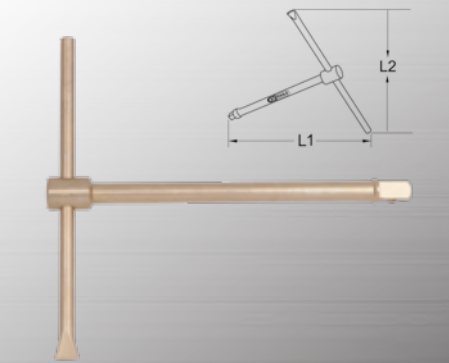

	1/2"	L1 mm	L2 mm	g	€
963.1286	1/2"	245,0	220,0	500	170,50

BRONZEplus Bit socket for phillips head screws PH

- PH
- Internal square to DIN 3120 / ISO 1174 with ball reception
- Non-sparking
- Explosion proof
- Corrosion resistant
- Wear resistant
- Aluminium-Bronze (Non-Ferrous-Alloy)

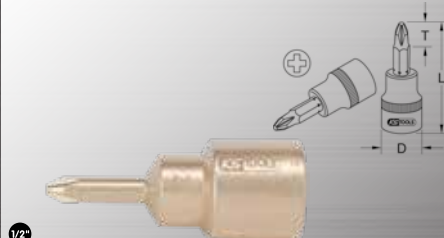

		D mm	L mm	T mm	g	€
963.1296	PH 1	25,0	60,0	8,0	140	57,90
963.1297	PH 2	25,0	60,0	8,0	140	66,50
963.1298	PH 3	25,0	60,0	8,0	140	100,50
963.1299	PH 4	25,0	60,0	8,0	140	106,90

BRONZEplus Socket set

- 6 point
- Non-sparking
- Explosion proof
- Corrosion resistant
- Wear resistant
- Aluminium-Bronze (Non-Ferrous-Alloy)
- In durable plastic storage case



		g	€
963.1288	11 pcs BRONZEplus Socket set	5,30	921,50
9 x	10 - 11 - 13 - 14 - 15 - 17 - 19 - 22 - 24 mm		
1 x	100 mm		
1 x	250 mm		

BRONZEplus T-handle

- In accordance to DIN 3122 / ISO 3315
- Square drive in accordance to DIN 3122 / ISO 1174 with ball lock
- With flexible head
- For difficult to access areas
- Non-sparking
- Explosion proof
- Corrosion resistant
- Wear resistant
- Aluminium-Bronze (Non-Ferrous-Alloy)

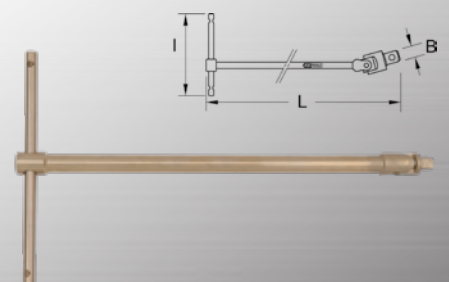

	1/2"	B mm	I mm	L mm	g	€
963.1287	1/2"	12,5	250,0	460,0	760	291,50

BRONZEplus Bit socket for hexagon screws



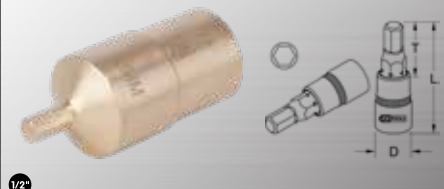

- Hexagon socket
- In accordance with DIN 7422
- Internal square drive to DIN 3120 / ISO 1174 with ball reception
- Non-sparking
- Explosion proof
- Corrosion resistant
- Wear resistant
- Aluminium-Bronze (Non-Ferrous-Alloy)



	mm	D mm	L mm	T mm	g	€
963.1300	4	25,0	60,0	12,0	110	64,50
963.1301	5	25,0	60,0	12,0	70	64,50
963.1302	6	25,0	60,0	12,0	70	64,50
963.1303	7	25,0	60,0	12,0	110	66,50
963.1304	8	25,0	60,0	12,0	80	66,50
963.1305	9	25,0	60,0	12,0	110	66,50
963.1306	10	25,0	60,0	12,0	110	75,90
963.1307	12	25,0	60,0	12,0	120	75,90
963.1308	14	25,0	60,0	12,0	130	75,90
963.1309	17	25,0	60,0	12,0	140	106,90
963.1310	19	25,0	60,0	12,0	230	127,50

		g	€
963.1289	23 pcs BRONZEplus Socket set	4,10	1695,90
22 x	10-11-12-13-14-15-16-17-18-19-20-21-22-23-24-25-26-27-28-29-30-32 mm		
1 x	250 mm		

		kg	€
963.1290	24 pcs	BRONZEplus Socket set	2,00 1877,90
22 x		10-11-12-13-14-15-16-17-18-19-20-21-22-23-24-25-26-27-28-29-30-32mm	
1 x		250 mm	
1 x		250 mm	

		kg	€
963.1291	26 pcs	BRONZEplus Socket set	4,10 2120,90
22 x		10-11-12-13-14-15-16-17-18-19-20-21-22-23-24-25-26-27-28-29-30-32mm	
1 x		250 mm	
1 x		250 mm	
1 x		320 mm	
1 x		380 mm	



BRONZEplus Bit socket set for hexagon screws

- Hexagon socket
- In accordance with DIN 7422
- Internal square drive to DIN 3120 / ISO 1174 with ball reception
- Non-sparking
- Explosion proof
- Corrosion resistant
- Wear resistant
- Aluminium-Bronze (Non-Ferrous-Alloy)
- In wooden box with spark-free hinges



		kg	€
963.1322	9 pcs	BRONZEplus Bit socket set for hexagon screws	1,24 787,50
9 x		1/2": 5 - 6 - 7 - 8 - 9 - 10 - 12 - 14 - 17 mm	

		kg	€
963.1323	11 pcs	BRONZEplus Bit socket set for hexagon screws	2,99 1048,50
1 x		1/2"	
1 x		1/2": 250 mm	
9 x		1/2": 5 - 6 - 7 - 8 - 9 - 10 - 12 - 14 - 17 mm	

		kg	€
963.1324	15 pcs	BRONZEplus Bit socket set for hexagon screws	2,79 1091,50
9 x		1/2": 5 - 6 - 7 - 8 - 9 - 10 - 12 - 14 - 17 mm	
6 x		1/2": 5/90 - 6/90 - 8/90 - 10/140 - 12/140 - 14/140 mm	

3/4" DRIVE NON SPARKING SOCKETS

BRONZEplus socket

- 6 point
- In accordance with DIN 3124 / ISO 2725-1
- Internal square to DIN 3120 / ISO 1174 with ball reception
- Non-sparking
- Explosion proof
- Corrosion resistant
- Wear resistant
- Aluminium-Bronze (Non-Ferrous-Alloy)



	mm	D1 mm	D2 mm	L mm	kg	€
963.3405	18	31,0	36,0	60,0	180	79,50
963.3406	19	32,0	36,0	60,0	180	79,50
963.3407	21	34,0	36,0	60,0	180	79,50
963.3408	22	36,0	36,0	60,0	180	79,50
963.3409	24	38,0	36,0	55,0	350	82,50
963.3410	25	39,0	36,0	55,0	350	82,50
963.3411	26	40,0	36,0	50,0	330	88,90
963.3412	27	41,0	36,0	50,0	300	88,90
963.3413	28	42,0	38,0	50,0	300	88,90
963.3414	29	43,0	38,0	50,0	300	94,50
963.3415	30	45,0	38,0	50,0	310	94,50
963.3416	32	48,0	40,0	60,0	430	102,90
963.3417	33	50,0	40,0	60,0	450	133,90
963.3418	34	50,0	40,0	60,0	470	133,90
963.3419	35	51,0	44,0	55,0	400	133,90
963.3420	36	52,0	44,0	60,0	430	133,90
963.3421	38	55,0	46,0	60,0	490	139,50
963.3422	41	64,0	50,0	65,0	560	151,90
963.3423	42	64,0	50,0	65,0	600	170,50
963.3424	46	68,0	50,0	65,0	840	181,90
963.3425	50	72,0	55,0	70,0	1080	200,50
963.3426	55	80,0	60,0	70,0	900	248,50
963.3427	58	80,0	60,0	60,0	950	278,50
963.3428	60	82,0	60,0	70,0	1290	314,50

		D1 mm	D2 mm	L mm	kg	€
963.3429	7/8"	36,0	36,0	60,0	180	88,90
963.3430	15/16"	39,0	36,0	55,0	350	90,90
963.3431	1"	39,0	36,0	55,0	350	100,50
963.3432	1.1/16"	41,0	36,0	50,0	300	106,90
963.3433	1.1/8"	41,0	36,0	50,0	300	106,90
963.3434	1.1/4"	48,0	40,0	60,0	430	127,50
963.3435	1.5/16"	50,0	40,0	60,0	400	145,50
963.3436	1.3/8"	52,0	44,0	55,0	400	157,50
963.3437	1.7/16"	55,0	46,0	60,0	430	157,50
963.3438	1.1/2"	55,0	46,0	60,0	490	170,50
963.3439	1.9/16"	55,0	46,0	60,0	490	181,90
963.3440	1.5/8"	64,0	50,0	65,0	560	181,90
963.3441	1.11/16"	64,0	50,0	65,0	560	211,90
963.3442	1.3/4"	68,0	50,0	65,0	600	211,90
963.3443	1.13/16"	68,0	50,0	65,0	840	211,90
963.3444	1.7/8"	68,0	50,0	65,0	1000	241,90
963.3445	2"	72,0	55,0	70,0	700	241,90



BERYLLIUMplus reversible ratchet

- In accordance with DIN 3122 / ISO 3315
- Square drive to DIN 3120 / ISO 1174 with ball lock
- Reversible
- Gearing with 45 teeth
- Non-sparking
- Explosion proof
- Corrosion resistant
- Very breakage resistant
- Copper Beryllium (Non-Ferrous-Alloy)



		A mm	D mm	L mm	kg	€
962.3490	3/4"	22,0	59,0	300,0	1,90	472,90

BERYLLIUMplus Ratchet handle with coupler

- Square drive to DIN 3120 / ISO 1174 with ball lock
- The direction of rotation (clockwise and counter clockwise) can be changed by simply rotating the square drive piece
- Non-sparking
- Explosion proof
- Corrosion resistant
- Very breakage resistant
- Copper Beryllium (Non-Ferrous-Alloy)



		A mm	D mm	L mm	kg	€
962.3491	3/4"	22,0	60,0	500,0	1,80	381,90

BRONZEplus Coupler

- Square drive to DIN 3120 / ISO 1174 with ball lock
- Non-sparking
- Explosion proof
- Corrosion resistant
- Wear resistant
- Aluminium-Bronze (Non-Ferrous-Alloy)

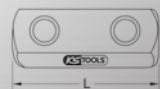

		L mm	kg	€
963.3457	3/4"	51,5	130	52,50

BRONZEplus extension

- In accordance to DIN 3123 / ISO 3316
- Square drive to DIN 3120 / ISO 1174 with ball lock
- Internal square to DIN 3120 / ISO 1174 with ball reception
- Non-sparking
- Explosion proof
- Corrosion resistant
- Wear resistant
- Aluminium-Bronze (Non-Ferrous-Alloy)



	■	L mm	kg	€
963.3446	3/4"	100,0	0,35	88,90
963.3447	3/4"	250,0	0,70	151,90
963.3448	3/4"	380,0	1,67	236,50
963.3449	3/4"	430,0	1,50	266,50

BRONZEplus flexi drive handle

- In accordance to DIN 3122 / ISO 3315
- Square drive to DIN 3120 / ISO 1174 with ball lock
- Non-sparking
- Explosion proof
- Corrosion resistant
- Wear resistant
- Aluminium-Bronze (Non-Ferrous-Alloy)

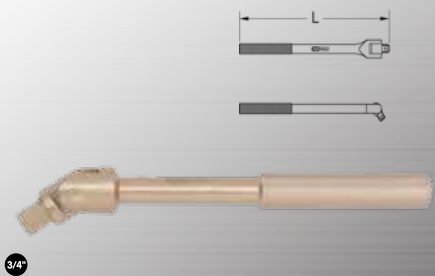

	■	L mm	kg	€
963.3450	3/4"	380,0	1,40	291,50
963.3451	3/4"	460,0	1,30	339,50
963.3452	3/4"	550,0	1,95	405,50

BRONZEplus sliding T-handle

- In accordance to DIN 3122 / ISO 3315
- Square drive to DIN 3120 / ISO 1174 with ball lock
- Non-sparking
- Explosion proof
- Corrosion resistant
- Wear resistant
- Aluminium-Bronze (Non-Ferrous-Alloy)

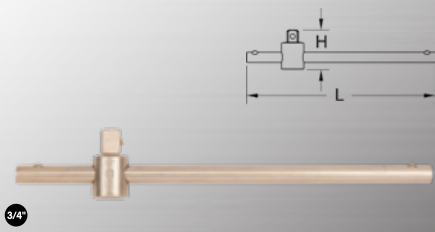

	■	H mm	L mm	kg	€
963.3453	3/4"	65,0	260,0	0,60	200,50
963.3454	3/4"	65,0	500,0	1,48	254,90

BRONZEplus adaptor and reducing adaptor

- In accordance to DIN 3123 / ISO 3316
- Square drive to DIN 3120 / ISO 1174 with ball lock
- Internal square to DIN 3120 / ISO 1174 with ball reception
- Non-sparking
- Explosion proof
- Corrosion resistant
- Wear resistant
- Aluminium-Bronze (Non-Ferrous-Alloy)



	□	■	L mm	kg	€
963.3455	3/4"	1"	61,0	300	100,50
963.3456	3/4"	1/2"	57,0	150	66,50

BRONZEplus universal joint

- In accordance to DIN 3123 / ISO 3316
- Square drive to DIN 3120 / ISO 1174 with ball lock
- Internal square to DIN 3120 / ISO 1174 with ball reception
- Non-sparking
- Explosion proof
- Corrosion resistant
- Wear resistant
- Aluminium-Bronze (Non-Ferrous-Alloy)



	□	■	L mm	kg	€
963.3458	3/4"	3/4"	85,0	550	109,50
963.3459	3/4"	3/4"	106,0	570	151,90

BRONZEplus L-Handle

- In accordance to DIN ISO 2936
- Square drive to DIN 3120 / ISO 1174 with ball lock
- Non-sparking
- Explosion proof
- Corrosion resistant
- Wear resistant
- Aluminium-Bronze (Non-Ferrous-Alloy)



	■	L mm	kg	€
963.3460	3/4"	300,0	800	157,50

BRONZEplus Speed brace

- Square drive to DIN 3120 / ISO 1174 with ball lock
- Non-sparking
- Explosion proof
- Corrosion resistant
- Wear resistant
- Aluminium-Bronze (Non-Ferrous-Alloy)

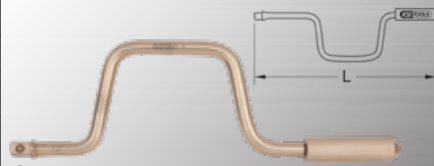

	■	L mm	kg	€
963.3461	3/4"	380,0	1,25	266,50

BRONZEplus T-handle

- In accordance to DIN 3122 / ISO 3315
- Square drive to DIN 3120 / ISO 1174 with ball lock
- Non-sparking
- Explosion proof
- Corrosion resistant
- Wear resistant
- Aluminium-Bronze (Non-Ferrous-Alloy)

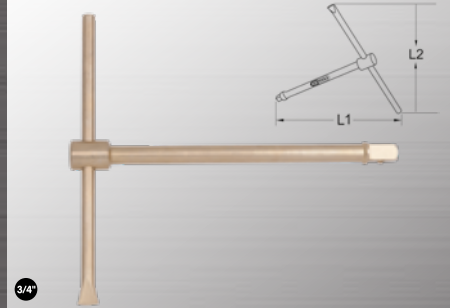

	■	L1 mm	L2 mm	kg	€
963.3462	3/4"	260,0	250,0	850	211,90

BRONZEplus T-handle

- In accordance to DIN 3122 / ISO 3315
- Square drive in accordance to DIN 3122 / ISO 1174 with ball lock
- With flexible head
- For difficult to access areas
- Non-sparking
- Explosion proof
- Corrosion resistant
- Wear resistant
- Aluminium-Bronze (Non-Ferrous-Alloy)

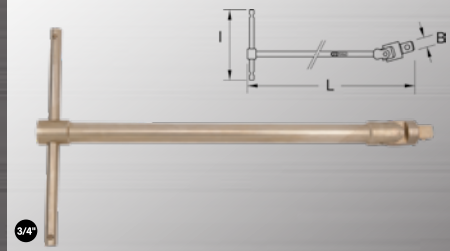

	■	B mm	I mm	L mm	kg	€
963.3463	3/4"	20,0	300,0	560,0	1,20	618,50

BRONZEplus Bit socket for hexagon screws

- Hexagon socket
- In accordance with DIN 7422
- Internal square drive to DIN 3120 / ISO 1174 with ball reception
- Non-sparking
- Explosion proof
- Corrosion resistant
- Wear resistant
- Aluminium-Bronze (Non-Ferrous-Alloy)

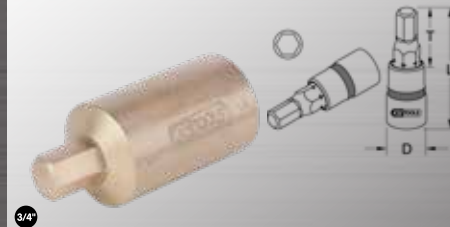

	■	D mm	L mm	T mm	kg	€
963.3465	14	36,0	80,0	18,0	350	109,50
963.3466	17	36,0	80,0	18,0	390	118,90
963.3467	19	36,0	80,0	18,0	440	120,90
963.3468	22	36,0	80,0	18,0	480	120,90
963.3469	24	36,0	80,0	18,0	520	120,90
963.3470	27	36,0	80,0	18,0	550	145,50
963.3471	30	36,0	80,0	18,0	570	145,50
963.3472	32	36,0	80,0	18,0	590	157,50
963.3473	36	36,0	80,0	18,0	620	157,50
963.3474	41	36,0	90,0	18,0	720	170,50
963.3475	46	36,0	90,0	18,0	820	170,50

BRONZEplus Socket set

- 6 point
- Non-sparking
- Explosion proof
- Corrosion resistant
- Wear resistant
- Aluminium-Bronze (Non-Ferrous-Alloy)
- In durable plastic storage case



	kg	€
963.3464 12 pcs BRONZEplus Socket set	12,70	2665,50
7 x  36 - 38 - 41 - 46 - 50 - 55 - 60 mm		
1 x  380 mm		
1 x  300 mm		
1 x  500 mm		
1 x  380 mm		

1" DRIVE NON SPARKING SOCKETS

BRONZEplus socket

- 6 point
- In accordance to DIN 3124 / ISO 2725-1
- Internal square to DIN 3120 / ISO 1174 with ball reception
- Non-sparking
- Explosion proof
- Corrosion resistant
- Wear resistant
- Aluminium-Bronze (Non-Ferrous-Alloy)



	mm	D1 mm	D2 mm	L mm	kg	€
963.0088	19	33,0	46,0	55,0	0,28	79,50
963.0089	21	35,0	46,0	55,0	0,30	88,90
963.0091	22	37,0	46,0	55,0	0,33	88,90
963.0092	24	39,0	47,0	55,0	0,34	100,50
963.0093	26	42,0	47,0	55,0	0,35	127,50
963.0094	27	44,0	48,0	55,0	0,36	127,50
963.0095	29	46,0	48,0	60,0	0,37	127,50
963.0096	30	48,0	50,0	60,0	0,41	133,90
963.1005	32	50,0	50,0	60,0	0,51	133,90
963.1006	36	52,0	50,0	65,0	0,55	157,50
963.1007	41	63,0	50,0	70,0	0,73	205,50
963.1008	42	63,0	50,0	65,0	0,71	205,50
963.1009	46	67,0	52,0	65,0	0,71	218,50
963.1010	50	72,0	52,0	70,0	0,93	223,90
963.1011	55	78,0	60,0	75,0	1,13	230,50
963.1012	60	83,0	60,0	75,0	1,35	266,50
963.1013	65	90,0	65,0	75,0	1,50	291,50
963.1014	70	98,0	75,0	85,0	1,75	327,50
963.1015	75	104,0	75,0	85,0	2,30	369,50
963.1016	80	110,0	85,0	85,0	2,50	381,90
963.1017	85	116,0	85,0	90,0	2,80	551,50
963.1018	90	120,0	90,0	85,0	4,40	630,50
963.1019	95	130,0	95,0	85,0	4,50	641,90
963.1020	100	136,0	95,0	85,0	4,60	696,50

		D1 mm	D2 mm	L mm	kg	€
963.1021	1.7/16"	52,0	50,0	65,0	0,55	157,50
963.1022	1.1/2"	54,0	50,0	65,0	0,68	170,50
963.1023	1.5/8"	63,0	50,0	70,0	0,73	193,90
963.1024	1.1/16"	65,0	50,0	65,0	0,71	223,90
963.1025	1.13/16"	68,0	52,0	65,0	0,71	230,50
963.1026	1.7/8"	69,0	52,0	65,0	0,73	230,50
963.1027	2"	70,0	52,0	70,0	0,93	236,50
963.1028	2.1/16"	73,0	60,0	70,0	0,95	266,50
963.1029	2.3/16"	77,0	60,0	75,0	1,13	278,50
963.1030	2.3/8"	82,0	65,0	75,0	1,13	278,50
963.1031	2.1/4"	80,0	65,0	75,0	1,35	278,50
963.1032	2.7/16"	83,0	65,0	75,0	1,40	350,90
963.1033	2.9/16"	90,0	70,0	75,0	1,50	350,90
963.1034	2.5/8"	91,0	70,0	75,0	1,55	381,90
963.1035	2.3/4"	96,0	75,0	85,0	1,75	314,50
963.1037	2.15/16"	103,0	80,0	85,0	2,30	418,50
963.1038	3"	104,0	80,0	85,0	2,35	484,90
963.1039	3.1/8"	110,0	80,0	85,0	2,50	496,50
963.1040	3.3/8"	116,0	85,0	90,0	2,80	775,90
963.1041	3.1/2"	120,0	90,0	90,0	4,40	787,50
963.1042	3.3/4"	130,0	95,0	90,0	4,50	921,50
963.1043	3.7/8"	135,0	95,0	90,0	4,60	1182,50
963.1044	4.1/4"	113,0	85,0	90,0	5,00	1634,90

BERYLLIUMplus reversible ratchet

- In accordance to DIN 3122 / ISO 3315
- Square drive to DIN 3120 / ISO 1174 with ball lock
- Reversible
- Gearing with 45 teeth
- Non-sparking
- Explosion proof
- Corrosion resistant
- Very breakage resistant
- Copper Beryllium (Non-Ferrous-Alloy)

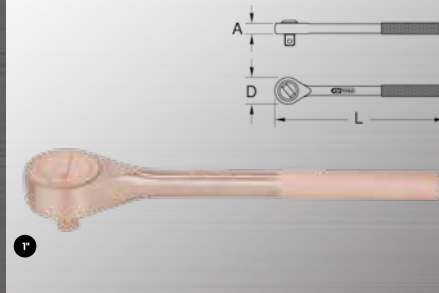

	A mm	D mm	L mm	kg	€	
962.1090	1"	30,0	72,0	550,0	340	775,90

BERYLLIUMplus Ratchet handle with coupler

- Square drive to DIN 3120 / ISO 1174 with ball lock
- The direction of rotation (clockwise and counter clockwise) can be changed by simply rotating the square drive piece
- Non-sparking
- Explosion proof
- Corrosion resistant
- Very breakage resistant
- Copper Beryllium (Non-Ferrous-Alloy)

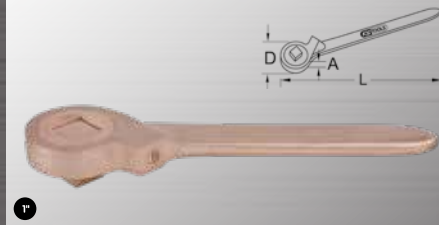

	A mm	D mm	L mm	kg	€	
962.1091	1"	23,0	72,0	550,0	3,50	539,50



BRONZEplus Coupler

- Square drive to DIN 3120 / ISO 1174 with ball lock
- Non-sparking
- Explosion proof
- Corrosion resistant
- Wear resistant
- Aluminium-Bronze (Non-Ferrous-Alloy)

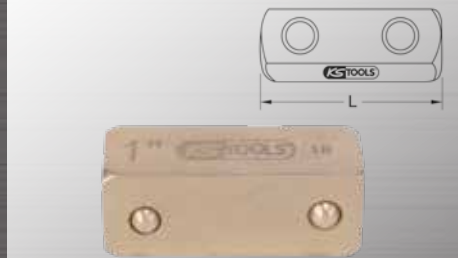

	L mm	kg	€	
963.1051	1"	68,0	300	48,50

BRONZEplus extension

- In accordance to DIN 3123 / ISO 3316
- Square drive to DIN 3120 / ISO 1174 with ball lock
- Internal square to DIN 3120 / ISO 1174 with ball reception
- Non-sparking
- Explosion proof
- Corrosion resistant
- Wear resistant
- Aluminium-Bronze (Non-Ferrous-Alloy)



	L mm	kg	€	
963.1045	1"	100,0	0,80	157,50
963.1046	1"	250,0	1,40	223,90
963.1047	1"	400,0	2,09	527,50

BRONZEplus flexi drive handle

- In accordance to DIN 3122 / ISO 3315
- Square drive to DIN 3120 / ISO 1174 with ball lock
- Non-sparking
- Explosion proof
- Corrosion resistant
- Wear resistant
- Aluminium-Bronze (Non-Ferrous-Alloy)



	L mm	kg	€	
963.1048	1"	380,0	1,20	266,50

BRONZEplus sliding T-handle

- In accordance to DIN 3122 / ISO 3315
- Square drive to DIN 3120 / ISO 1174 with ball lock
- Non-sparking
- Explosion proof
- Corrosion resistant
- Wear resistant
- Aluminium-Bronze (Non-Ferrous-Alloy)

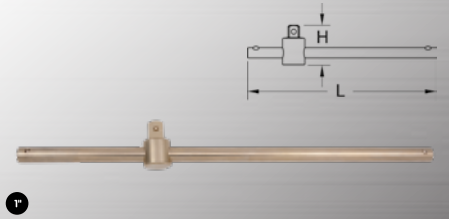

	■	H mm	L mm	kg	€
963.1049	1"	76,0	700,0	2,80	448,50

BRONZEplus reducing adaptor

- In accordance to DIN 3123 / ISO 3316
- Square drive to DIN 3120 / ISO 1174 with ball lock
- Internal square to DIN 3120 / ISO 1174 with ball reception
- Non-sparking
- Explosion proof
- Corrosion resistant
- Wear resistant
- Aluminium-Bronze (Non-Ferrous-Alloy)

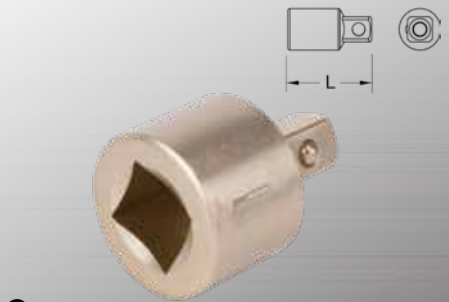

	□	■	L mm	kg	€
963.1050	1"	3/4"	75,0	540	79,50

BRONZEplus universal joint

- In accordance to DIN 3123 / ISO 3316
- Square drive to DIN 3120 / ISO 1174 with ball lock
- Internal square to DIN 3120 / ISO 1174 with ball reception
- Non-sparking
- Explosion proof
- Corrosion resistant
- Wear resistant
- Aluminium-Bronze (Non-Ferrous-Alloy)

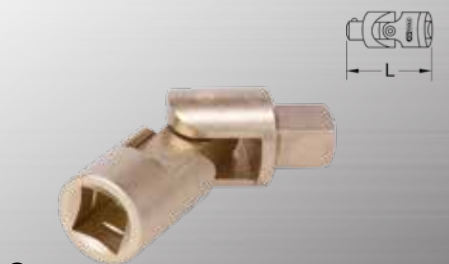

	□	■	L mm	kg	€
963.1052	1"	1"	141,0	1,45	187,50



BRONZEplus L-Handle

- In accordance to DIN ISO 2936
- Square drive to DIN 3120 / ISO 1174 with ball lock
- Non-sparking
- Explosion proof
- Corrosion resistant
- Wear resistant
- Aluminium-Bronze (Non-Ferrous-Alloy)



	■	L mm	kg	€
963.1053	1"	300,0	1,00	157,50

BRONZEplus Speed brace

- Square drive to DIN 3120 / ISO 1174 with ball lock
- Non-sparking
- Explosion proof
- Corrosion resistant
- Wear resistant
- Aluminium-Bronze (Non-Ferrous-Alloy)

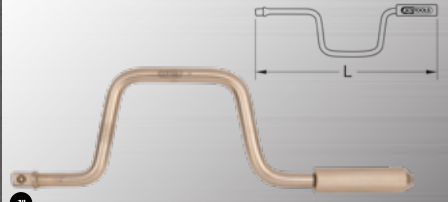

	■	L mm	kg	€
963.1054	1"	380,0	1,40	393,90

BRONZEplus T-handle

- In accordance to DIN 3122 / ISO 3315
- Square drive in accordance to DIN 3122 / ISO 1174 with ball lock
- With flexible head
- For difficult to access areas
- Non-sparking
- Explosion proof
- Corrosion resistant
- Wear resistant
- Aluminium-Bronze (Non-Ferrous-Alloy)

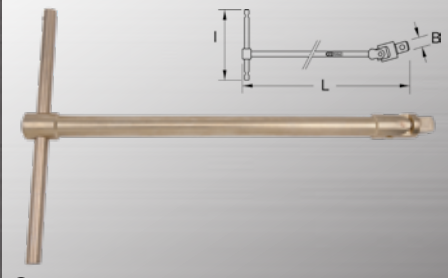

	■	B mm	I mm	L mm	kg	€
963.1055	1"	25,0	400,0	660,0	1,70	721,50

BRONZEplus Bit socket for hexagon screws

- Hexagon socket
- In accordance with DIN 7422
- Internal square drive to DIN 3120 / ISO 1174 with ball reception
- Non-sparking
- Explosion proof
- Corrosion resistant
- Wear resistant
- Aluminium-Bronze (Non-Ferrous-Alloy)



	mm	D mm	L mm	T mm	kg	€
963.1056	17	47,0	90,0	23,0	0,58	139,50
963.1057	19	47,0	90,0	23,0	0,67	139,50
963.1058	22	47,0	90,0	23,0	0,71	151,90
963.1059	24	47,0	90,0	23,0	0,77	151,90
963.1060	27	47,0	90,0	23,0	0,86	170,50
963.1061	30	47,0	90,0	23,0	0,91	170,50
963.1062	32	47,0	90,0	23,0	0,95	205,50
963.1063	36	47,0	90,0	23,0	0,99	205,50
963.1064	41	47,0	100,0	23,0	1,20	211,90
963.1065	46	47,0	100,0	23,0	1,40	211,90

BRONZEplus Socket set

- 6 point
- Non-sparking
- Explosion proof
- Corrosion resistant
- Wear resistant
- Aluminium-Bronze (Non-Ferrous-Alloy)
- In durable plastic storage case



		kg	€
963.1066	23 pcs BRONZEplus Socket set	33,10	6968,90
10 x	36 - 41 - 46 - 50 - 55 - 60 - 65 - 70 - 75 - 80 mm		
10 x	1.1/2" - 1.5/8" - 1.7/8" - 2" - 2.1/16" - 2.1/4" - 2.3/8" - 2.9/16" - 2.3/4" - 3"		
2 x	250 - 400 mm		
1 x	550 mm		

		kg	€
963.1067	13 pcs BRONZEplus Socket set	21,10	4181,50
10 x	36 - 41 - 46 - 50 - 55 - 60 - 65 - 70 - 75 - 80 mm		
2 x	250 - 400 mm		
1 x	550 mm		

1 1/2" DRIVE NON SPARKING SOCKETS

BRONZEplus socket

- 6 point
- In accordance to DIN 3124 / ISO 2725-1
- Internal square to DIN 3120 / ISO 1174 with ball reception
- Non-sparking
- Explosion proof
- Corrosion resistant
- Wear resistant
- Aluminium-Bronze (Non-Ferrous-Alloy)



	mm	D1 mm	D2 mm	L mm	kg	€
963.0001	55	81,0	74,0	90,0	2,30	327,50
963.0002	60	87,0	74,0	90,0	2,50	381,90
963.0003	65	94,0	74,0	95,0	2,85	418,50
963.0004	70	99,0	80,0	98,0	3,10	496,50
963.0005	75	105,0	80,0	100,0	3,40	545,90
963.0006	80	112,0	80,0	105,0	3,80	587,50
963.0007	85	118,0	80,0	110,0	4,20	654,90
963.0008	90	124,0	90,0	115,0	4,49	702,90

NON SPARKING SCREWDRIVERS

BERYLLIUMplus screwdriver for slotted screws

- Slotted
- In accordance to DIN ISO 2380-2 / 2380-1 Form A
- With hanging hole
- Two component handle
- Non-sparking
- Explosion proof
- Corrosion resistant
- Very breakage resistant
- Copper Beryllium (Non-Ferrous-Alloy)

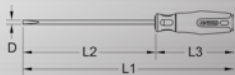

	D mm	L1 mm	L2 mm	L3 mm	kg	€
962.0911	3,0	165,0	75,0	90,0	30	21,50
962.0307	4,0	152,0	50,0	102,0	35	21,50
962.0308	4,0	177,0	75,0	102,0	40	21,50
962.0309	4,0	202,0	100,0	102,0	45	21,50
962.0912	4,5	200,0	100,0	100,0	30	21,50
962.0913	4,5	250,0	150,0	100,0	60	24,90
962.0311	5,0	177,0	75,0	102,0	65	27,90
962.0312	5,0	202,0	100,0	109,0	70	27,90
962.0914	6,0	200,0	100,0	100,0	80	27,90
962.0314	6,0	134,0	125,0	109,0	95	36,50
962.0915	6,0	250,0	150,0	100,0	90	36,50
962.0916	8,0	260,0	150,0	110,0	130	39,50
962.0315	8,0	321,0	200,0	121,0	155	52,50
962.0316	9,0	371,0	250,0	121,0	175	66,50
962.0917	10,0	320,0	200,0	120,0	190	66,50
962.0317	10,0	371,0	250,0	121,0	195	79,50
962.0918	10,0	420,0	300,0	120,0	230	84,50
962.0319	11,0	421,0	300,0	121,0	175	90,90
962.0321	11,0	421,0	350,0	121,0	300	100,50
962.0322	12,0	521,0	400,0	121,0	430	115,50

BERYLLIUMplus screwdriver for slotted screws, parallel blade

- With parallel blade
- Slotted
- With hanging hole
- Two component handle
- Non-sparking
- Explosion proof
- Corrosion resistant
- Very breakage resistant
- Copper Beryllium (Non-Ferrous-Alloy)



	D mm	L1 mm	L2 mm	L3 mm	kg	€
962.0920	3,0	165,0	75,0	90,0	20	24,90
962.0921	4,0	240,0	150,0	100,0	20	34,50
962.0922	5,0	250,0	150,0	100,0	30	34,50
962.0923	6,0	300,0	200,0	100,0	110	39,50
962.0924	6,5	400,0	300,0	100,0	150	64,50

BERYLLIUMplus screwdriver for Phillips screws PH

- PH
- In accordance to DIN 5262 / ISO 8764-1
- With hanging hole
- Two component handle
- Non-sparking
- Explosion proof
- Corrosion resistant
- Very breakage resistant
- Copper Beryllium (Non-Ferrous-Alloy)



		L1 mm	L2 mm	L3 mm	kg	€
962.0900	PH 0	150,0	60,0	90,0	30	21,50
962.0011	PH 1	152,0	50,0	102,0	45	21,50
962.0901	PH 1	170,0	80,0	90,0	60	21,50
962.0012	PH 1	202,0	100,0	102,0	70	24,90
962.0902	PH 2	200,0	100,0	100,0	90	24,90
962.0013	PH 2	234,0	125,0	109,0	95	34,50
962.0014	PH 2	259,0	150,0	109,0	105	36,50
962.0903	PH 3	250,0	150,0	100,0	170	39,50
962.0015	PH 3	321,0	200,0	121,0	185	52,50
962.0016	PH 3	371,0	250,0	121,0	200	60,90
962.0904	PH 4	310,0	200,0	110,0	270	64,50
962.0017	PH 4	471,0	350,0	121,0	280	90,90
962.0018	PH 4	521,0	400,0	121,0	300	106,90
962.0019	PH 4	571,0	450,0	121,0	320	118,90

BERYLLIUMplus screwdriver set

- With hanging hole
- Two component handle
- Non-sparking
- Explosion proof
- Corrosion resistant
- Very breakage resistant
- Copper Beryllium (Non-Ferrous-Alloy)



		kg	€
962.0805	4 pcs BERYLLIUMplus screwdriver set	320	106,90
4 x	3 (75 mm) - 4,5 (100 mm) - 6 - 8 (150 mm)		

BERYLLIUMplus screwdriver set

- With hanging hole
- Two component handle
- Non-sparking
- Explosion proof
- Corrosion resistant
- Very breakage resistant
- Copper Beryllium (Non-Ferrous-Alloy)



		kg	€
962.0808	4 pcs BERYLLIUMplus screwdriver set	400	157,50
4 x	PH1 - PH2 - PH3 - PH4		

BERYLLIUMplus screwdriver set

- With hanging hole
- Two component handle
- Non-sparking
- Explosion proof
- Corrosion resistant
- Very breakage resistant
- Copper Beryllium (Non-Ferrous-Alloy)



		kg	€
962.0806	6 pcs BERYLLIUMplus screwdriver set	500	157,50
4 x	4,5 - 6 (100 mm) - 6 - 8 (150 mm)		
2 x	PH1 - PH2		

BERYLLIUMplus screwdriver set

- With hanging hole
- Two component handle
- Non-sparking
- Explosion proof
- Corrosion resistant
- Very breakage resistant
- Copper Beryllium (Non-Ferrous-Alloy)



		kg	€
962.0807	10 pcs BERYLLIUMplus screwdriver set	1,20	314,50
6 x	4,5 - 6 (100 mm) - 4,5 - 6 - 8 (150 mm) - 10 (200 mm)		
4 x	PH1 - PH2 - PH3 - PH4		

BERYLLIUMplus screwdriver for Torx screws

- Torx
- With hanging hole
- Two component handle
- Non-sparking
- Explosion proof
- Corrosion resistant
- Very breakage resistant
- Copper Beryllium (Non-Ferrous-Alloy)

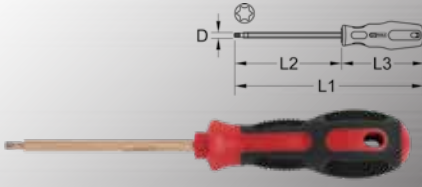

		L1 mm	L2 mm	L3 mm	g	€
962.0930	T5	160,0	70,0	90,0	30	36,50
962.0931	T6	160,0	70,0	90,0	70	36,50
962.0932	T7	160,0	70,0	90,0	70	36,50
962.0933	T8	160,0	70,0	90,0	70	36,50
962.0934	T9	160,0	70,0	90,0	70	39,50
962.0935	T10	170,0	80,0	90,0	80	39,50
962.0936	T15	170,0	80,0	90,0	80	42,90
962.0937	T20	190,0	90,0	100,0	80	52,50
962.0938	T25	190,0	90,0	100,0	100	60,90
962.0939	T27	210,0	110,0	100,0	100	66,50
962.0940	T30	210,0	110,0	100,0	110	66,50
962.0941	T40	220,0	120,0	100,0	120	75,90
962.0942	T45	230,0	120,0	110,0	140	84,50
962.0943	T50	230,0	120,0	110,0	150	90,90

BRONZEplus screwdriver for hexagon screws

- 6 point
- With hanging hole
- Two component handle
- Non-sparking
- Explosion proof
- Corrosion resistant
- Wear resistant
- Aluminium-Bronze (Non-Ferrous-Alloy)



	mm	L1 mm	L2 mm	L3 mm	g	€
963.1068	3,0	190,0	100,0	90,0	40	18,50
963.1069	4,0	190,0	100,0	90,0	50	18,50
963.1070	5,0	200,0	100,0	100,0	60	18,50
963.1071	6,0	225,0	125,0	100,0	90	27,90
963.1072	8,0	260,0	150,0	110,0	140	27,90
963.1073	10,0	260,0	150,0	110,0	210	46,50
963.1074	12,0	280,0	150,0	130,0	280	46,50

BRONZEplus screwdriver for hexagon screws, angled

- 6 point
- With hanging hole
- Two component handle
- Non-sparking
- Explosion proof
- Corrosion resistant
- Wear resistant
- Aluminium-Bronze (Non-Ferrous-Alloy)

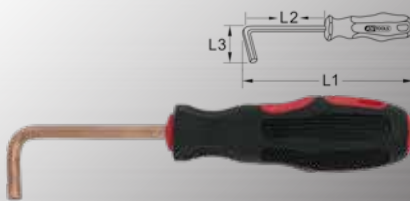

	mm	L1 mm	L2 mm	L3 mm	g	€
963.1505	3,0	153,0	75,0	20,0	40	18,50
963.1506	4,0	153,0	75,0	25,0	40	18,50
963.1507	5,0	180,0	80,0	28,0	50	18,50
963.1508	6,0	180,0	80,0	32,0	100	27,90
963.1509	8,0	240,0	120,0	36,0	140	27,90
963.1510	10,0	240,0	120,0	40,0	220	34,50
963.1511	12,0	240,0	120,0	45,0	290	36,50

BERYLLIUMplus screwdriver for hexagon screws with ball end

- 6 point
- With hanging hole
- Two component handle
- Non-sparking
- Explosion proof
- Corrosion resistant
- Very breakage resistant
- Copper Beryllium (Non-Ferrous-Alloy)

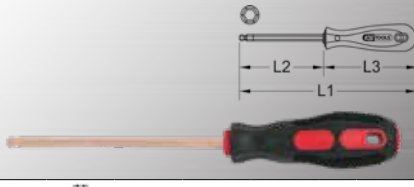

	mm	L1 mm	L2 mm	L3 mm	g	€
962.0950	3,0	190,0	100,0	90,0	30	39,50
962.0951	4,0	190,0	100,0	90,0	50	42,90
962.0952	5,0	200,0	100,0	100,0	60	42,90
962.0953	6,0	225,0	125,0	100,0	90	57,90
962.0954	8,0	260,0	150,0	110,0	140	90,90
962.0955	10,0	260,0	150,0	110,0	210	151,90
962.0956	12,0	280,0	150,0	130,0	280	200,50

NON SPARKING OFFSET SCREWDRIVERS

BRONZEplus key wrench for hexagon socket screws, short

- 6 point
- Short execution
- In accordance to DIN ISO 2936
- Non-sparking
- Explosion proof
- Corrosion resistant
- Wear resistant
- Aluminium-Bronze (Non-Ferrous-Alloy)



	mm	L1 mm	L2 mm	g	€	
962.04015	1,5		55,0	13,0	0,01	16,50
962.0402	2,0		55,0	13,0	0,01	16,50
962.04025	2,5		55,0	13,0	0,01	16,50
963.1519	3,0		60,0	25,0	0,01	18,50
963.1520	4,0		70,0	30,0	0,01	20,50
963.1521	5,0		80,0	32,0	0,02	18,50
963.1522	6,0		90,0	37,0	0,04	21,50
963.1523	7,0		95,0	43,0	0,04	21,50
963.1524	8,0		100,0	44,0	0,07	26,90
963.1525	9,0		105,0	44,0	0,07	27,90
963.1526	10,0		115,0	45,0	0,10	36,50
963.1527	11,0		119,0	48,0	0,13	39,50
963.1528	12,0		125,0	52,0	0,13	46,50
963.1529	13,0		132,0	54,0	0,20	54,50
963.1530	14,0		140,0	58,0	0,25	64,50
963.1531	17,0		160,0	65,0	0,32	79,50
963.1532	18,0		170,0	69,0	0,50	84,50
963.1533	19,0		180,0	72,0	0,57	90,90
963.1534	22,0		200,0	77,0	0,95	112,50
963.1535	24,0		224,0	82,0	1,25	120,90
963.1536	27,0		250,0	93,0	1,80	145,50
963.1537	30,0		280,0	105,0	2,50	170,50
963.1538	32,0		315,0	116,0	3,10	211,90
963.1539	36,0		355,0	128,0	4,50	266,50
963.1540	41,0		400,0	140,0	5,30	369,50
962.0420		3/64"	55,0	13,0	0,01	33,50
962.0421		1/16"	55,0	13,0	0,01	33,50
962.0422		5/64"	55,0	13,0	0,01	33,50
962.0423		3/32"	55,0	13,0	0,01	36,50
962.0424		1/8"	60,0	24,0	0,01	40,90
962.0425		5/32"	70,0	30,0	0,02	47,50

	mm	L1 mm	L2 mm	g	€
963.1541	3/16"	80,0	31,0	0,02	64,50
963.1542	7/32"	80,0	37,0	0,02	64,50
963.1543	1/4"	90,0	37,0	0,04	64,50
963.1544	5/16"	100,0	44,0	0,07	64,50
963.1545	3/8"	120,0	45,0	0,10	64,50
963.1546	7/16"	119,0	48,0	0,13	64,50
963.1547	1/2"	125,0	55,0	0,18	66,50
963.1548	9/16"	140,0	58,0	0,25	75,90
963.1549	5/8"	140,0	63,0	0,30	90,90
963.1550	11/16"	160,0	65,0	0,32	97,50
963.1551	3/4"	180,0	73,0	0,57	100,50
963.1552	7/8"	200,0	77,0	0,95	118,90
963.1553	1"	224,0	85,0	1,26	145,50
963.1554	1.1/16"	216,0	93,0	3,08	157,50
963.1555	1.1/8"	230,0	95,0	3,30	181,90
963.1556	1.1/4"	230,0	116,0	3,30	266,50
963.1557	1.5/16"	235,0	116,0	3,52	357,50
963.1558	1.3/8"	235,0	128,0	3,52	369,50
963.1559	1.7/16"	241,0	128,0	3,74	369,50
963.1560	1.1/2"	241,0	128,0	3,74	527,50
963.1561	1.5/8"	241,0	140,0	3,74	527,50

BRONZEplus Hexagon key wrench set in a folding holder, short

- 6 point
- Short execution
- In accordance to DIN ISO 2936
- Non-sparking
- Explosion proof
- Corrosion resistant
- Wear resistant
- Aluminium-Bronze (Non-Ferrous-Alloy)



	g	€	
963.1512	8 pcs 2 - 2,5 - 3 - 4 - 5 - 6 - 8 - 10 mm	280	145,50
963.1513	9 pcs 1,5 - 2 - 2,5 - 3 - 4 - 5 - 6 - 8 - 10 mm	280	170,50
963.1514	10 pcs 1/16" - 5/64" - 3/32" - 1/8" - 5/32" - 3/16" - 7/32" - 1/4" - 5/16" - 3/8"	300	418,50

BRONZEplus key wrench for hexagon socket screws, extra long

- 6 point
- Extra long execution
- In accordance to DIN ISO 2936
- Non-sparking
- Explosion proof
- Corrosion resistant
- Wear resistant
- Aluminium-Bronze (Non-Ferrous-Alloy)



	mm	L1 mm	L2 mm	g	€
963.1562	3,0	126,0	25,0	100	21,50
963.1563	4,0	142,0	30,0	30	21,50
963.1564	5,0	160,0	32,0	40	21,50
963.1565	6,0	180,0	37,0	30	24,90
963.1566	8,0	200,0	44,0	70	27,90
963.1567	10,0	205,0	45,0	120	36,50
963.1568	12,0	250,0	52,0	190	57,90
963.1569	14,0	280,0	58,0	300	84,50
963.1570	17,0	320,0	65,0	380	109,50
963.1571	19,0	360,0	72,0	490	145,50

BRONZEplus Hexagon key wrench set in a folding holder, extra long

- 6 point
- Long execution
- In accordance to DIN ISO 2936
- Non-sparking
- Explosion proof
- Corrosion resistant
- Wear resistant
- Aluminium-Bronze (Non-Ferrous-Alloy)



	mm	€
963.1515	8 pcs 2 - 2,5 - 3 - 4 - 5 - 6 - 8 - 10 mm	400 181,90
963.1516	9 pcs 1,5 - 2 - 2,5 - 3 - 4 - 5 - 6 - 8 - 10 mm	480 200,50

BRONZEplus Hexagon key wrench set in a folding holder, with ball end

- 6 point
- In accordance to DIN ISO 2936
- With ball head on the long end
- Non-sparking
- Explosion proof
- Corrosion resistant
- Wear resistant
- Aluminium-Bronze (Non-Ferrous-Alloy)

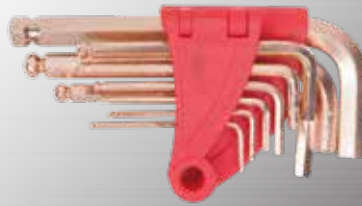

	mm	€
963.1517	8 pcs 2 - 2,5 - 3 - 4 - 5 - 6 - 8 - 10 mm	250 291,50
963.1518	9 pcs 1,5 - 2 - 2,5 - 3 - 4 - 5 - 6 - 8 - 10 mm	260 309,50

BERYLLIUMplus T-handle hexagon key wrench with ball end

- 6 point
- One component handle
- Non-sparking
- Explosion proof
- Corrosion resistant
- Very breakage resistant
- Copper Beryllium (Non-Ferrous-Alloy)

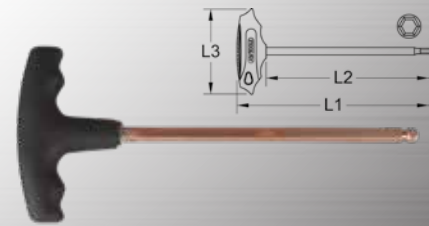

	mm	L1 mm	L2 mm	L3 mm	g	€
962.0960	3,0	145,0	100,0	75,0	40	39,50
962.0961	4,0	145,0	100,0	75,0	40	39,50
962.0962	5,0	205,0	150,0	91,0	650	42,90
962.0963	6,0	205,0	150,0	91,0	90	66,50
962.0964	8,0	205,0	150,0	91,0	120	90,90
962.0965	10,0	255,0	200,0	91,0	230	169,50
962.0966	12,0	255,0	200,0	91,0	300	236,50
962.0967	14,0	255,0	200,0	91,0	380	278,50

BERYLLIUMplus key wrench for hexagon socket screws with ball end, short

- 6 point
- Short execution
- Non-sparking
- Explosion proof
- Corrosion resistant
- Very breakage resistant
- Copper Beryllium (Non-Ferrous-Alloy)



	mm	L1 mm	L2 mm	g	€
962.0440	1,5	45,0	13,0	10	24,90
962.0441	2,0	50,0	16,0	10	24,90
962.0442	2,5	55,0	18,0	10	24,90
962.0443	3,0	63,0	20,0	10	27,90
962.0444	4,0	70,0	25,0	10	34,50
962.0445	5,0	80,0	28,0	20	46,50
962.0446	6,0	90,0	32,0	30	52,50
962.0447	7,0	95,0	34,0	40	57,90
962.0448	8,0	100,0	36,0	60	57,90
962.0449	10,0	115,0	40,0	110	84,50
962.0450	12,0	130,0	45,0	210	127,50
962.0451	14,0	140,0	48,0	260	139,50

BRONZEplus T-handle hexagon key wrench

- 6 point
- One component handle
- Non-sparking
- Explosion proof
- Corrosion resistant
- Wear resistant
- Aluminium-Bronze (Non-Ferrous-Alloy)

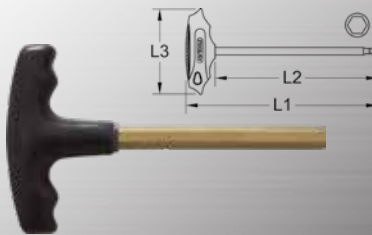

	mm	L1 mm	L2 mm	L3 mm	g	€
963.1572	3,0	143,0	100,0	75,0	20	16,50
963.1573	4,0	143,0	100,0	75,0	30	16,50
963.1574	5,0	155,0	100,0	91,0	40	21,50
963.1575	6,0	155,0	100,0	91,0	40	27,90
963.1576	8,0	155,0	100,0	91,0	60	27,90
963.1577	10,0	155,0	100,0	91,0	80	34,50
963.1578	12,0	155,0	100,0	91,0	160	42,90
963.1579	14,0	155,0	100,0	91,0	200	52,50

BRONZEplus Key wrench

- Slotted
- Non-sparking
- Explosion proof
- Corrosion resistant
- Wear resistant
- Aluminium-Bronze (Non-Ferrous-Alloy)

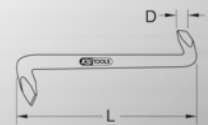

	D mm	L mm	g	€
963.1588	4,0	125,0	50	24,90
963.1589	6,0	130,0	100	52,50
963.1590	10,0	140,0	90	57,90
963.1591	13,0	190,0	240	127,50

BERYLLIUMplus key wrench for hexagon socket screws with ball end, extra long

- 6 point
- Extra long execution
- Non-sparking
- Explosion proof
- Corrosion resistant
- Very breakage resistant
- Copper Beryllium (Non-Ferrous-Alloy)



	mm	L1 mm	L2 mm	g	€
962.0460	3,0	126,0	20,0	10	34,50
962.0461	4,0	140,0	25,0	20	39,50
962.0462	5,0	160,0	28,0	30	52,50
962.0463	6,0	180,0	32,0	50	64,50
962.0464	7,0	190,0	34,0	80	79,50
962.0465	8,0	200,0	36,0	100	79,50
962.0466	10,0	224,0	40,0	180	112,50
962.0467	12,0	250,0	45,0	290	145,50
962.0468	14,0	290,0	48,0	370	170,50

BRONZEplus T-handle hexagon key wrench, long

- 6 point
- Extra long execution
- One component handle
- Non-sparking
- Explosion proof
- Corrosion resistant
- Wear resistant
- Aluminium-Bronze (Non-Ferrous-Alloy)

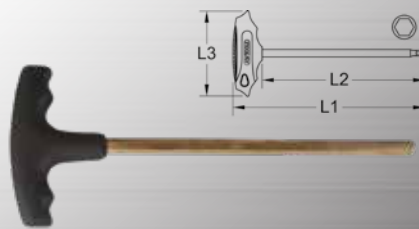

	mm	L1 mm	L2 mm	L3 mm	g	€
963.1580	3,0	195,0	150,0	75,0	30	21,50
963.1581	4,0	195,0	150,0	75,0	40	24,90
963.1582	5,0	205,0	150,0	91,0	60	27,90
963.1583	6,0	205,0	150,0	91,0	100	34,50
963.1584	8,0	205,0	150,0	91,0	130	36,50
963.1585	10,0	205,0	150,0	91,0	140	39,50
963.1586	12,0	205,0	150,0	91,0	160	46,50
963.1587	14,0	205,0	150,0	91,0	190	57,90



BRONZEplus offset screwdriver for square head screws

- 4 point
- Non-sparking
- Explosion proof
- Corrosion resistant
- Wear resistant
- Aluminium-Bronze (Non-Ferrous-Alloy)



	mm	L1 mm	L2 mm	kg	€
963.1592	10	200,0	37,0	0,20	70,90
963.1593	11	200,0	37,0	0,20	70,90
963.1594	12	200,0	42,0	0,20	70,90
963.1595	13	200,0	45,0	0,20	70,90
963.1596	14	220,0	45,0	0,40	72,90
963.1597	15	220,0	48,0	0,40	72,90
963.1598	16	220,0	48,0	0,40	75,90
963.1599	17	250,0	51,0	0,60	88,90
963.1600	18	250,0	53,0	0,60	94,50
963.1601	19	250,0	55,0	0,60	94,50
963.1602	20	300,0	57,0	1,00	94,50
963.1603	21	300,0	57,0	1,00	112,50
963.1604	22	300,0	59,0	1,00	112,50
963.1605	24	360,0	63,0	1,60	127,50
963.1606	25	360,0	63,0	1,60	127,50
963.1607	27	360,0	69,0	1,60	151,90
963.1608	28	440,0	69,0	3,20	248,50
963.1609	30	440,0	75,0	3,20	248,50
963.1610	32	440,0	81,0	3,20	248,50

NON SPARKING PLIERS

BRONZEplus one handed pipe wrench

- Non-sparking
- Explosion proof
- Corrosion resistant
- Wear resistant
- Aluminium-Bronze (Non-Ferrous-Alloy)

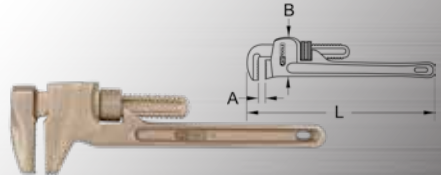

	A mm	B mm	L mm	kg	€
963.1705	38,0	50,0	240,0	0,42	145,50
963.1706	45,0	50,0	240,0	0,47	145,50
963.1707	48,0	53,0	290,0	0,78	170,50
963.1708	58,0	64,0	350,0	1,00	291,50
963.1709	65,0	64,0	350,0	1,20	314,50
963.1710	70,0	75,0	425,0	1,60	393,90
963.1711	80,0	80,0	500,0	2,20	1023,90
963.1712	105,0	90,0	575,0	3,70	1332,50

BRONZEplus pipe wrench

- In accordance to DIN 5234
- 90° angled
- S-shaped jaw
- Non-sparking
- Explosion proof
- Corrosion resistant
- Very breakage resistant
- Aluminium-Bronze (Non-Ferrous-Alloy)

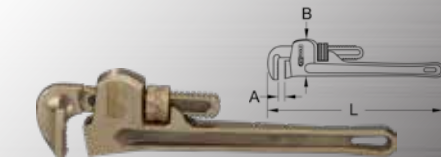

	A mm	B mm	L mm	kg	€
963.0021	25,0	48,0	183,0	0,35	106,90
963.0022	30,0	59,0	239,0	0,60	145,50
963.0023	40,0	68,0	275,0	0,84	187,50
963.0024	50,0	72,0	315,0	1,15	211,90
963.0025	60,0	83,0	400,0	1,95	314,50
963.0026	70,0	96,0	530,0	3,00	460,50
963.0027	85,0	121,0	780,0	5,00	654,90
963.0028	110,0	152,0	1090,0	8,50	1091,50

BERYLLIUMplus swedish pipe wrench

- In accordance to DIN 5234
- 45° angled
- S-shaped jaw
- Non-sparking
- Explosion proof
- Corrosion resistant
- Very breakage resistant
- Copper Beryllium (Non-Ferrous-Alloy)

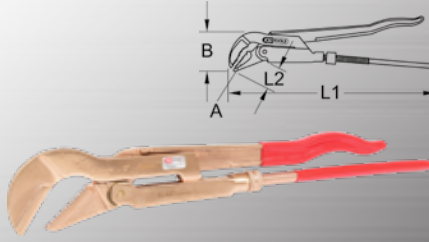

	A	B mm	L1 mm	L2 mm	kg	€
962.4005	1"	60,0	200,0	38,0	0,82	575,90
962.4006	1.1/2"	70,0	300,0	50,0	1,57	668,90
962.4007	2"	72,0	350,0	65,0	3,20	763,90
962.4008	3"	100,0	600,0	75,0	4,10	1271,50
962.4009	4"	122,0	900,0	100,0	6,20	1514,50

BERYLLIUMplus adjustable pipe wrench

- In accordance to DIN 5234
- 90° angled
- S-shaped jaw
- Non-sparking
- Explosion proof
- Corrosion resistant
- Very breakage resistant
- Copper Beryllium (Non-Ferrous-Alloy)

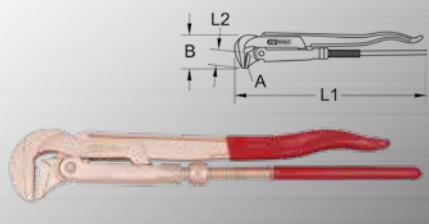

	A	B mm	L1 mm	L2 mm	kg	€
962.4015	1.1/2"	80,0	435,0	50,0	1,57	430,50
962.4016	2"	95,0	540,0	65,0	3,20	848,50

BERYLLIUMplus adjustable spanner

- Non-sparking
- Explosion proof
- Corrosion resistant
- Very breakage resistant
- Copper Beryllium (Non-Ferrous-Alloy)

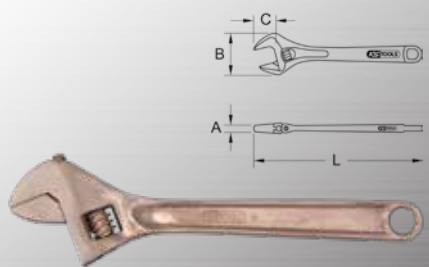

	mm	A mm	B mm	C mm	L mm	kg	€
962.1108	18	9,0	45,0	18,0	150,0	0,10	118,90
962.1109	26	10,0	55,0	20,0	200,0	0,20	139,50
962.1110	30	11,0	65,0	30,0	250,0	0,40	181,90
962.1111	36	12,0	83,0	34,0	300,0	0,70	223,90
962.1112	46	15,0	105,0	47,0	380,0	1,40	332,90
962.1113	53	17,0	123,0	51,0	450,0	2,70	478,50
962.1114	67	19,0	145,0	62,0	600,0	5,10	787,50

BRONZEplus chain pipe wrench

- Function is similar to a ratchet
- Light execution
- Non-sparking
- Explosion proof
- Corrosion resistant
- Wear resistant
- Aluminium-Bronze (Non-Ferrous-Alloy)

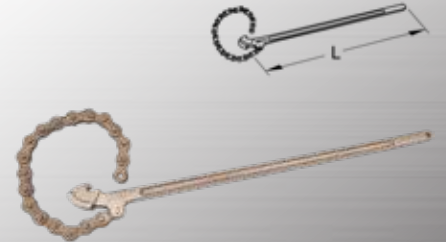

	Ø mm	L mm	kg	€
963.1713	50	600,0	1,70	575,90
963.1714	100	600,0	2,50	605,90
963.1715	150	600,0	3,00	1103,50
963.1716	450	1600,0	8,00	1575,50

BRONZEplus chain pipe wrench

- Function is similar to a ratchet
- American version
- Non-sparking
- Explosion proof
- Corrosion resistant
- Wear resistant
- Aluminium-Bronze (Non-Ferrous-Alloy)

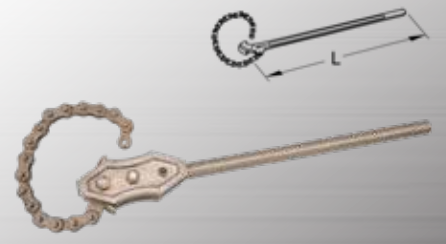

	Ø mm	L mm	kg	€
963.1717	38	510,0	2,65	787,50
963.1718	65	685,0	4,50	823,90
963.1719	100	915,0	11,50	1453,50
963.1720	300	1830,0	30,30	3151,50

BERYLLIUMplus pipe wrench

- With PVC dipped handle
- Non-sparking
- Explosion proof
- Corrosion resistant
- Very breakage resistant
- Copper Beryllium (Non-Ferrous-Alloy)

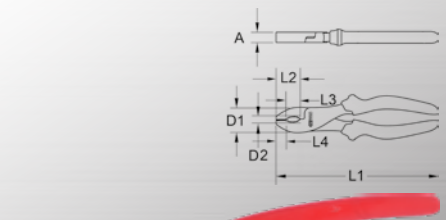

	A mm	D1 mm	D2 mm	L1 mm	L2 mm	L3 mm	L4 mm	kg	€
962.0607	12,0	30,0	15,0	210,0	40,0	25,0	15,0	370	157,50

BERYLLIUMplus combination pliers

- Non-sparking
- Explosion proof
- Corrosion resistant
- Very breakage resistant
- Copper Beryllium (Non-Ferrous-Alloy)
- Two component handle

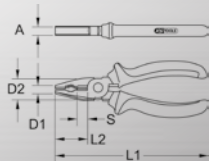

	A mm	D1 mm	D2 mm	L1 mm	L2 mm	S mm	g	€
962.0620	10,0	7,0	24,0	160,0	33,0	12,0	350	139,50
962.0621	14,0	9,0	29,0	200,0	38,0	16,0	420	157,50

BERYLLIUMplus high leverage side cutter

- In accordance to DIN ISO 5749
- Two component handle
- For different wire types
- Non-sparking
- Explosion proof
- Corrosion resistant
- Very breakage resistant
- Copper Beryllium (Non-Ferrous-Alloy)

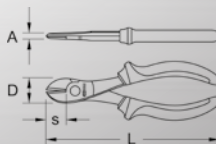

	A mm	D mm	L mm	S mm	g	€
962.0617	14,0	30,0	190,0	24,0	290	181,90

BERYLLIUMplus flat pliers

- Non-sparking
- Explosion proof
- Corrosion resistant
- Very breakage resistant
- Copper Beryllium (Non-Ferrous-Alloy)
- Two component handle

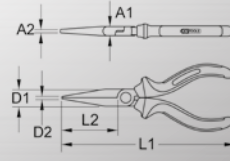

	A1 mm	A2 mm	D1 mm	D2 mm	L1 mm	L2 mm	g	€
962.0630	9,0	2,5	18,0	3,2	160,0	48,0	50	112,50
962.0631	11,0	4,0	21,0	5,0	200,0	85,0	150	139,50

BERYLLIUMplus combination pliers, adjustable

- Two component handle
- Adjustable
- Non-sparking
- Explosion proof
- Corrosion resistant
- Very breakage resistant
- Copper Beryllium (Non-Ferrous-Alloy)

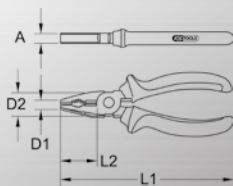

	A mm	D1 mm	D2 mm	L1 mm	L2 mm	g	€
962.0623	14,0	9,0	29,0	200,0	38,0	340	181,90

BERYLLIUMplus waterpump pliers

- In accordance to DIN ISO 8976
- Insulated handle
- Non-sparking
- Explosion proof
- Corrosion resistant
- Very breakage resistant
- Copper Beryllium (Non-Ferrous-Alloy)

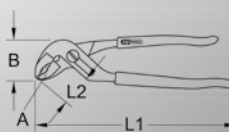

	A mm	B mm	L1 mm	L2 mm	g	€
962.0605	30,0	53,0	250,0	33,0	350	230,50

BERYLLIUMplus telephone pliers

- Non-sparking
- Explosion proof
- Corrosion resistant
- Very breakage resistant
- Copper Beryllium (Non-Ferrous-Alloy)
- Two component handle

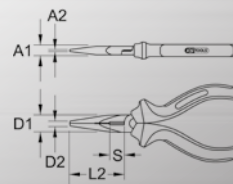

	A1 mm	A2 mm	D1 mm	D2 mm	L1 mm	L2 mm	S mm	g	€
962.0610	11,0	3,0	22,0	4,0	180,0	60,0	10,0	300	145,50

BERYLLIUMplus side cutters

- In accordance to DIN ISO 5749
- Two component handle
- For different wire types
- Non-sparking
- Explosion proof
- Corrosion resistant
- Very breakage resistant
- Copper Beryllium (Non-Ferrous-Alloy)

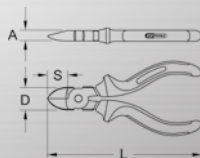

	A mm	D mm	L mm	S mm	g	€
962.0616	10,0	23,0	165,0	20,0	200	163,90
962.0333	13,0	29,0	200,0	29,0	410	211,90

BERYLLIUMplus round nosed pliers

- Non-sparking
- Explosion proof
- Corrosion resistant
- Very breakage resistant
- Copper Beryllium (Non-Ferrous-Alloy)
- Substantial through joint
- Two component handle

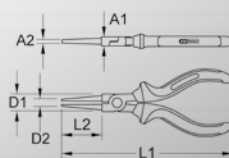

	A1 mm	A2 mm	D1 mm	D2 mm	L1 mm	L2 mm	g	€
962.0625	3,0	10,0	20,0	3,0	160,0	36,0	90	112,50
962.0626	5,0	12,0	25,0	4,0	200,0	54,0	160	139,50

BERYLLIUMplus telephone pliers, offset

- 45° angled tips
- Non-sparking
- Explosion proof
- Corrosion resistant
- Very breakage resistant
- Copper Beryllium (Non-Ferrous-Alloy)
- Insulated handle

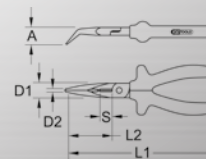

	A mm	D1 mm	D2 mm	L1 mm	L2 mm	S mm	g	€
962.0612	9,0	20,0	4,0	180,0	50,0	9,0	290	145,50

BERYLLIUMplus pincers

- With PVC dipped handle
- Non-sparking
- Explosion proof
- Corrosion resistant
- Very breakage resistant
- Copper Beryllium (Non-Ferrous-Alloy)

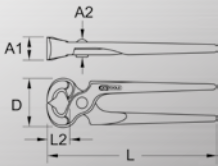

	A1 mm	A2 mm	D mm	L1 mm	L2 mm	kg	€
962.0640	16,0	14,0	43,0	175,0	19,0	430	170,50
962.0641	20,0	18,0	53,0	200,0	23,0	520	170,50

BERYLLIUMplus side cutter

- Strong execution
- With PVC dipped handle
- Non-sparking
- Explosion proof
- Corrosion resistant
- Very breakage resistant
- Copper Beryllium (Non-Ferrous-Alloy)

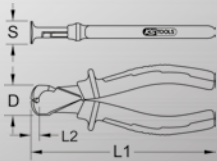

	D mm	L1 mm	L2 mm	S mm	kg	€
962.0615	30,0	175,0	9,0	28	260	193,90

BERYLLIUMplus wire stripper

- With spring and locking screw
- Non-sparking
- Explosion proof
- Corrosion resistant
- Very breakage resistant
- Copper Beryllium (Non-Ferrous-Alloy)

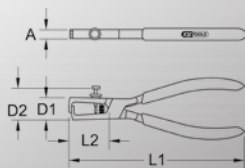

	A mm	D1 mm	D2 mm	L1 mm	L2 mm	kg	€
962.0635	10,0	25,0	28,0	170,0	40,0	260	211,90

BERYLLIUMplus Bolt cutters

- With PVC dipped handle
- Non-sparking
- Explosion proof
- Corrosion resistant
- Very breakage resistant
- Copper Beryllium (Non-Ferrous-Alloy)

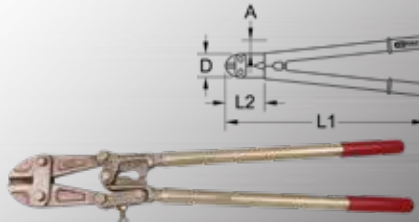

	A mm	D mm	L1 mm	L2 mm	kg	€
962.0619	62,0	78,0	620,0	140,0	3,40	684,90

BRONZEplus Non-sparking locking pliers

- Forged gripping jaws
- Serrated execution
- Size adjustment using the adjustment wheel
- With loosening lever
- With easy locking action
- For round and flat material
- To hold when welding
- No flaring under the strongest loads
- Loosening under continuous pressure of a national
- Very breakage resistant
- Aluminium-Bronze (Non-Ferrous-Alloy)



	A mm	L mm	S mm	kg	€
963.0331	16,0	254,0	42,0	700	200,50

BERYLLIUMplus Crimping pliers

- With PVC dipped handle
- Non-sparking
- Explosion proof
- Corrosion resistant
- Very breakage resistant
- Copper Beryllium (Non-Ferrous-Alloy)

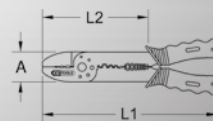

	L1 mm	L2 mm	A mm	kg	€
962.0636	200,0	120,0	40,0	120	211,90



BERYLLIUMplus pliers set

- Non-sparking
- Explosion proof
- Corrosion resistant
- Very breakage resistant
- Copper Beryllium (Non-Ferrous-Alloy)



	kg	€
962.0650 4 pcs BERYLLIUMplus pliers set	1,50	684,90

1 x		200 mm
1 x		165 mm
1 x		180 mm
1 x		250 mm

NON SPARKING TWEEZERS

BRONZEplus tweezers

- Non-sparking
- Explosion proof
- Corrosion resistant
- Wear resistant
- Aluminium-Bronze (Non-Ferrous-Alloy)

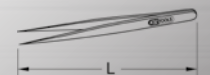

	L mm	kg	€
963.5604	100,0	100	16,50

BRONZEplus neat tweezers

- Non-sparking
- Explosion proof
- Corrosion resistant
- Wear resistant
- Aluminium-Bronze (Non-Ferrous-Alloy)



	L mm	kg	€
963.5605	150,0	30	42,90

BRONZEplus flat nose tweezers

- Non-sparking
- Explosion proof
- Corrosion resistant
- Wear resistant
- Aluminium-Bronze (Non-Ferrous-Alloy)



	L mm		€
963.5606	100,0	30	42,90

NON SPARKING DRILLS

BERYLLIUMplus twist drill

- Non-sparking
- Explosion proof
- Corrosion resistant
- Very breakage resistant
- Copper Beryllium (Non-Ferrous-Alloy)



	D mm	L1 mm	L2 mm	Content		€
962.9606	6,0	100,0	60,0	1	20	218,50
962.9607	7,0	120,0	70,0	1	30	223,90
962.9608	8,0	140,0	80,0	1	50	236,50
962.9609	9,0	160,0	100,0	1	70	248,50
962.9610	10,0	180,0	120,0	1	100	266,50
962.9611	11,0	200,0	130,0	1	120	272,90
962.9612	12,0	220,0	150,0	1	170	284,90
962.9613	13,0	240,0	160,0	1	220	291,50
962.9614	14,0	260,0	180,0	1	280	302,90
962.9615	15,0	280,0	200,0	1	360	309,50
962.9616	16,0	300,0	220,0	1	440	327,50
962.9617	17,0	300,0	220,0	1	500	350,90
962.9618	18,0	320,0	230,0	1	600	381,90
962.9619	19,0	320,0	230,0	1	700	393,90
962.9620	20,0	330,0	240,0	1	800	418,50

BERYLLIUMplus twist drill set

- Non-sparking
- Explosion proof
- Corrosion resistant
- Very breakage resistant
- Copper Beryllium (Non-Ferrous-Alloy)
- In durable plastic storage case



		€
962.9630	15 pcs 6-7-8-9-10-11-12-13-14-15-16-17-18-19-20mm	4,00 4484,50

NON SPARKING SAWS

BRONZEplus hack saw frame

- For saw blade length 300 mm
- Non-sparking
- Explosion proof
- Corrosion resistant
- Wear resistant
- Aluminium-Bronze (Non-Ferrous-Alloy)

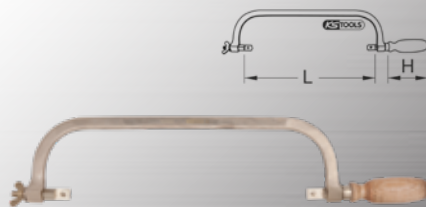

	L mm	H mm		€
963.5108	300	200	0,90	187,50

BERYLLIUMplus hack saw blade for hack saw frame

- Non-sparking
- Explosion proof
- Corrosion resistant
- Very breakage resistant
- Copper Beryllium (Non-Ferrous-Alloy)



	L2 mm	L3 mm	B mm	D mm		€
962.9034	300,0	1,0-1,3	12,0	0,6	30	46,50

BERYLLIUMplus hand saw

- Non-sparking
- Explosion proof
- Corrosion resistant
- Very breakage resistant
- Copper Beryllium (Non-Ferrous-Alloy)

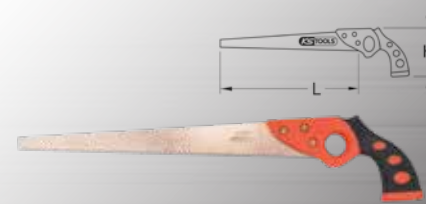

	L mm	H mm		€
962.9035	370,0	90,0	500	248,50

BERYLLIUMplus hand saw, heavy duty

- Non-sparking
- Explosion proof
- Corrosion resistant
- Very breakage resistant
- Copper Beryllium (Non-Ferrous-Alloy)



	L mm	H mm		€
962.9036	700,0	120,0	770	418,50

NON SPARKING WIRE BRUSHES

BRONZEplus tin bronze wire brush, curled

- Non-sparking
- Explosion proof
- Corrosion resistant
- Wear resistant
- Aluminium-Bronze (Non-Ferrous-Alloy)



	L mm	B mm		€
963.9580	125,0	55,0	300	52,50

BRONZEplus tin bronze wire brush, curled

- Non-sparking
- Explosion proof
- Corrosion resistant
- Wear resistant
- Aluminium-Bronze (Non-Ferrous-Alloy)

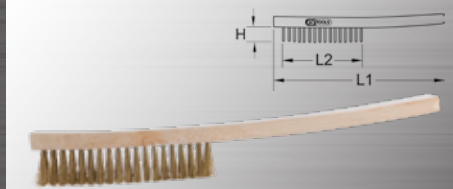

	rows	H mm	L1 mm	L2 mm		€
963.9581	3	30,0	350,0	120,0	190	21,50
963.9582	4	30,0	350,0	120,0	210	27,90
963.9583	5	30,0	350,0	120,0	190	46,50

BRONZEplus tin bronze wire handbrush, curled

- Non-sparking
- Explosion proof
- Corrosion resistant
- Wear resistant
- Aluminium-Bronze (Non-Ferrous-Alloy)

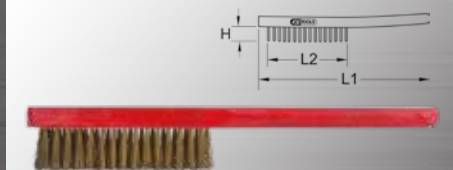

	rows	H mm	L1 mm	L2 mm		€
963.9584	3	30,0	290,0	120,0	110	39,50
963.9585	4	30,0	290,0	120,0	130	46,50
963.9586	5	30,0	290,0	120,0	150	66,50

BRONZEplus tin bronze wire hand broom, curled

- Non-sparking
- Explosion proof
- Corrosion resistant
- Wear resistant
- Aluminium-Bronze (Non-Ferrous-Alloy)

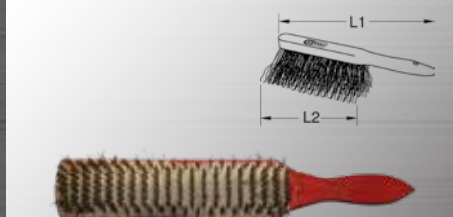

	L1 mm	L2 mm		€
963.9587	310,0	150,0	320	52,50

BRONZEplus Hand brush

- Without handle
- Non-sparking
- Explosion proof
- Corrosion resistant
- Wear resistant
- Aluminium-Bronze (Non-Ferrous-Alloy)

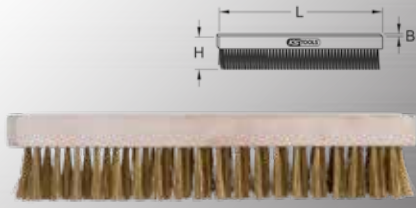

	L mm	B mm	H mm	g	€
963.9590	245,0	60,0	50,0	480	88,90

BRONZEplus round wire broom

- Non-sparking
- Explosion proof
- Corrosion resistant
- Wear resistant
- Aluminium-Bronze (Non-Ferrous-Alloy)

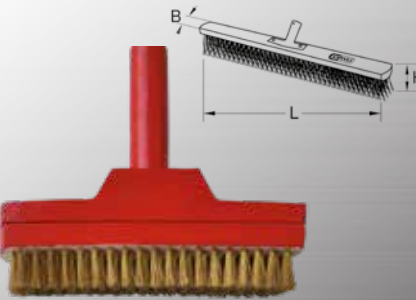

	L mm	B mm	H mm	g	€
963.9591	240,0	60,0	65,0	0,40	211,90

BRONZEplus Brush, spark-plug cleaning, round wire

- Non-sparking
- Explosion proof
- Corrosion resistant
- Wear resistant
- Aluminium-Bronze (Non-Ferrous-Alloy)

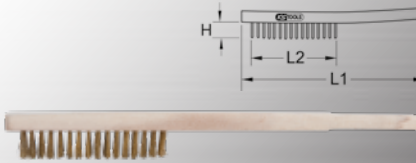

	H mm	L1 mm	L2 mm	g	€
963.9593	15,0	225,0	80,0	40	16,50

BRONZEplus tube brush, wire curled

- Non-sparking
- Explosion proof
- Corrosion resistant
- Wear resistant
- Aluminium-Bronze (Non-Ferrous-Alloy)

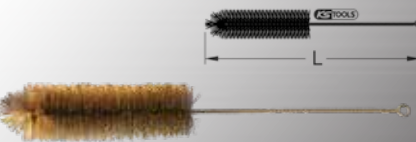

	L mm	g	€
963.9594	300,0	40	54,50

BRONZEplus brush end, wire curled

- Non-sparking
- Explosion proof
- Corrosion resistant
- Wear resistant
- Aluminium-Bronze (Non-Ferrous-Alloy)



	D1 mm	D2 mm	H mm	L mm	g	€
963.9595	26,0	6,0	30,0	80,0	640	94,50

BRONZEplus tin bronze wire wheel brush, curled

- Non-sparking
- Explosion proof
- Corrosion resistant
- Wear resistant
- Aluminium-Bronze (Non-Ferrous-Alloy)

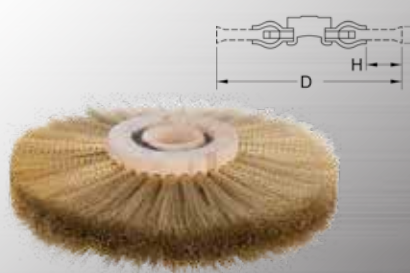

	A mm	D mm	H mm	g	€
963.9596	45,0	150,0	20,0	520	236,50

BRONZEplus tin bronze wire cup brush, curled

- Non-sparking
- Explosion proof
- Corrosion resistant
- Wear resistant
- Aluminium-Bronze (Non-Ferrous-Alloy)



	D mm	H mm	L mm	g	€
963.9597	85,0	20,0	35,0	700	218,50



NON SPARKING FILES

BERYLLIUMplus flat file

- In accordance to DIN 7261 Form A
- Two component handle
- With hanging hole
- Non-sparking
- Explosion proof
- Corrosion resistant
- Very breakage resistant
- Copper Beryllium (Non-Ferrous-Alloy)

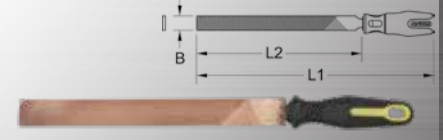

	B mm	L1 mm	L2 mm	g	€	
962.7301	1	25,0	360,0	245,0	330	139,50
962.7302	3	25,0	360,0	245,0	330	139,50

BERYLLIUMplus half round file

- In accordance to DIN 7261 Form E
- Two component handle
- With hanging hole
- Non-sparking
- Explosion proof
- Corrosion resistant
- Very breakage resistant
- Copper Beryllium (Non-Ferrous-Alloy)

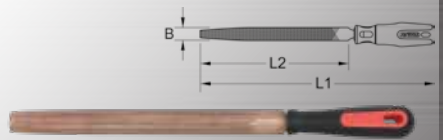

	B mm	L1 mm	L2 mm	g	€	
962.7101	1	22,0	365,0	250,0	340	145,50
962.7102	3	22,0	365,0	250,0	340	145,50

BERYLLIUMplus round file

- In accordance to DIN 7261 Form F
- Two component handle
- With hanging hole
- Non-sparking
- Explosion proof
- Corrosion resistant
- Very breakage resistant
- Copper Beryllium (Non-Ferrous-Alloy)

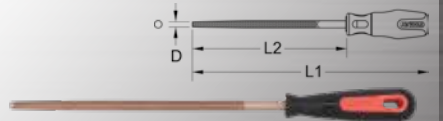

	D mm	L1 mm	L2 mm	g	€	
962.7201	1	8,0	360,0	250,0	180	133,90
962.7202	3	8,0	360,0	250,0	180	133,90

NON SPARKING KNIVES

BERYLLIUMplus cutter

- Durable and fixed blade
- With plastic handle
- Non-sparking
- Explosion proof
- Corrosion resistant
- Very breakage resistant
- Copper Beryllium (Non-Ferrous-Alloy)

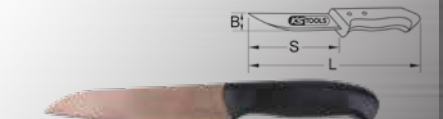

	B mm	L mm	S mm	g	€
962.9030	30,0	180,0	80	60	42,90

BRONZEplus cutter

- Durable and fixed blade
- With wooden handle
- Reinforced execution
- Non-sparking
- Explosion proof
- Corrosion resistant
- Wear resistant
- Aluminium-Bronze (Non-Ferrous-Alloy)

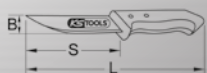

	B mm	L mm	S mm	g	€
963.9510	30,0	300,0	200	300	72,90

NON SPARKING SHEARS

BERYLLIUMplus metal shears

- Non-sparking
- Explosion proof
- Corrosion resistant
- Very breakage resistant
- Copper Beryllium (Non-Ferrous-Alloy)

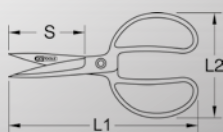

	L1 mm	L2 mm	S mm	g	€
962.9015	300,0	120,0	70,0	450	170,50

BERYLLIUMplus Ideal pattern

- Non-sparking
- Explosion proof
- Corrosion resistant
- Very breakage resistant
- Copper Beryllium (Non-Ferrous-Alloy)

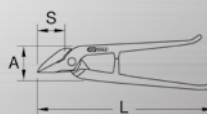

	A mm	L mm	S mm	g	€
962.9016	35,0	280,0	50	520	248,50

BERYLLIUMplus universal shear

- Non-sparking
- Explosion proof
- Corrosion resistant
- Very breakage resistant
- Copper Beryllium (Non-Ferrous-Alloy)

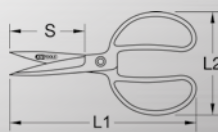

	L1 mm	L2 mm	S mm	g	€
962.9017	210,0	110,0	80,0	300	200,50

BERYLLIUMplus universal shear

- Non-sparking
- Explosion proof
- Corrosion resistant
- Very breakage resistant
- Copper Beryllium (Non-Ferrous-Alloy)

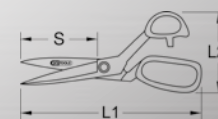

	L1 mm	L2 mm	S mm	g	€
962.9018	220,0	90,0	100	450	193,90

BERYLLIUMplus hedge shears

- Non-sparking
- Explosion proof
- Corrosion resistant
- Very breakage resistant
- Copper Beryllium (Non-Ferrous-Alloy)

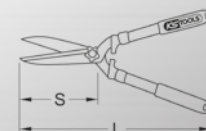

	L mm	S mm	g	€
962.9033	520,0	300	1,40	866,90

NON SPARKING CUTTING TOOLS

BRONZEplus reaping hook

- Non-sparking
- Explosion proof
- Corrosion resistant
- Wear resistant
- Aluminium-Bronze (Non-Ferrous-Alloy)

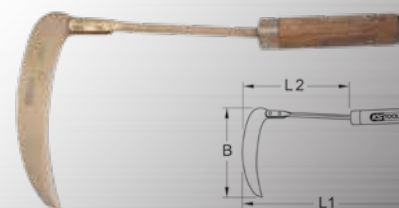

	L1 mm	L2 mm	B mm	g	€
963.9651	380,0	220,0	200,0	800	248,50

BRONZEplus draw knife

- Non-sparking
- Explosion proof
- Corrosion resistant
- Wear resistant
- Aluminium-Bronze (Non-Ferrous-Alloy)



	L mm	A mm	g	€
963.5705	650,0	250,0	1,50	405,50

NON SPARKING SCRAPERS

BRONZEplus deck scraper

- Non-sparking
- Explosion proof
- Corrosion resistant
- Wear resistant
- Aluminium-Bronze (Non-Ferrous-Alloy)

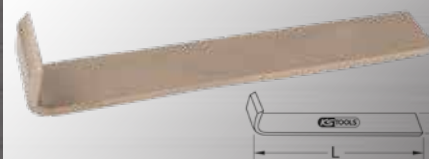

	L mm	B mm	g	€
963.9520	200,0	22,0	210	60,90
963.9521	255,0	40,0	480	70,90
963.9522	300,0	50,0	570	84,50

BRONZEplus deck scraper with handle

- Non-sparking
- Explosion proof
- Corrosion resistant
- Wear resistant
- Aluminium-Bronze (Non-Ferrous-Alloy)

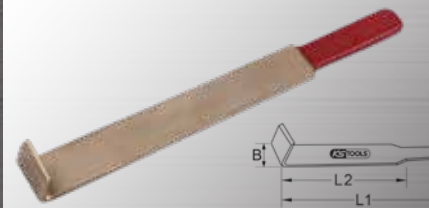

	L1 mm	L2 mm	B mm	g	€
963.9523	380,0	280,0	38,0	780	94,50

BRONZEplus spray booth scraper

- Non-sparking
- Explosion proof
- Corrosion resistant
- Wear resistant
- Aluminium-Bronze (Non-Ferrous-Alloy)

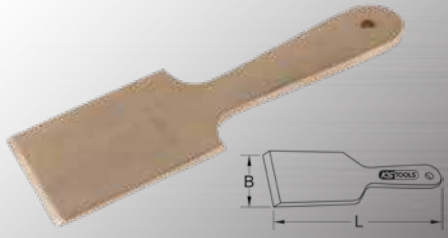

	L mm	B mm	kg	€
963.9530	235,0	75,0	450	64,50

BRONZEplus flat scraper

- In accordance to DIN 8350 Form A
- Work areas ground
- Two component handle
- With hanging hole
- Non-sparking
- Explosion proof
- Corrosion resistant
- Wear resistant
- Aluminium-Bronze (Non-Ferrous-Alloy)

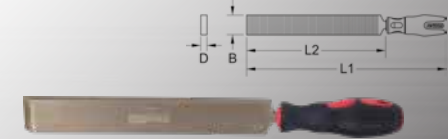

	B mm	D mm	L1 mm	L2 mm	kg	€
963.9531	37,0	6,0	315,0	205,0	290	64,50

BRONZEplus triangular scraper

- In accordance to DIN 8350 Form C
- Work areas ground
- Two component handle
- With hanging hole
- Non-sparking
- Explosion proof
- Corrosion resistant
- Wear resistant
- Aluminium-Bronze (Non-Ferrous-Alloy)



	B mm	L1 mm	L2 mm	kg	€
963.9532	16,0	365,0	255,0	220	66,50

BRONZEplus ship scraper

- In accordance to DIN 8350 Form C
- Work areas ground
- Non-sparking
- Explosion proof
- Corrosion resistant
- Wear resistant
- Aluminium-Bronze (Non-Ferrous-Alloy)

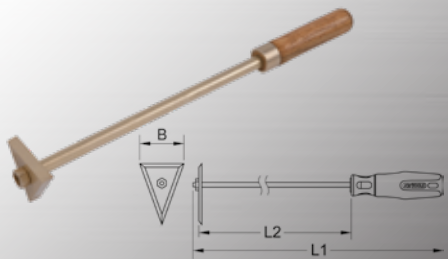

	L1 mm	L2 mm	B mm	kg	€
963.9533	420,0	100,0	70,0	650	145,50

BRONZEplus scraper with handle

- Non-sparking
- Explosion proof
- Corrosion resistant
- Wear resistant
- Aluminium-Bronze (Non-Ferrous-Alloy)

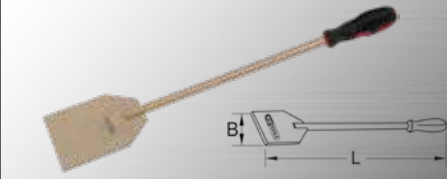

	L mm	B mm	kg	€
963.9534	480,0	95,0	620	163,90

BRONZEplus scraper

- Non-sparking
- Explosion proof
- Corrosion resistant
- Wear resistant
- Aluminium-Bronze (Non-Ferrous-Alloy)

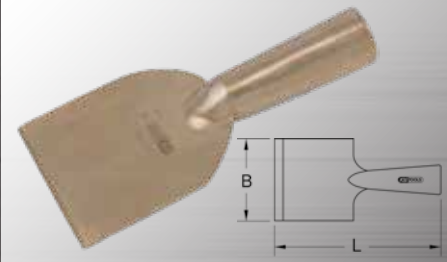

	L mm	B mm	kg	€
963.9535	220,0	75,0	0,58	82,50
963.9536	220,0	100,0	0,83	90,90
963.9537	220,0	125,0	0,88	139,50
963.9538	220,0	150,0	1,02	163,90

BRONZEplus scraper, concave

- Non-sparking
- Explosion proof
- Corrosion resistant
- Wear resistant
- Aluminium-Bronze (Non-Ferrous-Alloy)

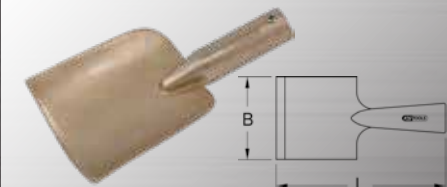

	L mm	B mm	kg	€
963.9539	240,0	100,0	0,90	112,50
963.9540	240,0	150,0	1,35	151,90

NON SPARKING FLANGE SPREADERS

BRONZEplus flange spreader

- Non-sparking
- Explosion proof
- Corrosion resistant
- Wear resistant
- Aluminium-Bronze (Non-Ferrous-Alloy)

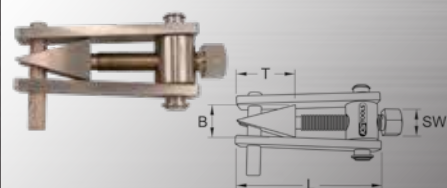

	mm	L mm	B mm	T mm	kg	€
963.5607	46	300,0	60,0	55,0	7,20	878,50

NON SPARKING HAMMERS

BRONZEplus ball pin hammer

- With fibreglass handle
- English type
- Surfaces polished ground
- Non-sparking
- Explosion proof
- Corrosion resistant
- Wear resistant
- Aluminium-Bronze (Non-Ferrous-Alloy)



	g	D1 mm	D2 mm	L1 mm	L2 mm	kg	€
963.0323	200	23,0	23,0	270,0	80,0	0,23	34,50
963.0324	300	26,0	26,0	285,0	90,0	0,34	39,50
963.0325	350	29,0	28,0	310,0	101,0	0,45	52,50
963.0326	600	34,0	37,0	345,0	116,0	0,68	72,90
963.0327	750	38,0	34,0	355,0	127,0	0,91	94,50
963.0328	950	40,0	38,0	355,0	137,0	1,13	118,90
963.0329	1100	42,0	41,0	405,0	147,0	1,35	145,50

BRONZEplus ball pin hammer

- With hickory handle
- American form
- Surfaces polished ground
- Non-sparking
- Explosion proof
- Corrosion resistant
- Wear resistant
- Aluminium-Bronze (Non-Ferrous-Alloy)



	g	D1 mm	D2 mm	L1 mm	L2 mm	kg	€
963.2105	100	20,0	17,0	310,0	50,0	0,25	42,90
963.2106	150	24,0	20,0	310,0	55,0	0,30	52,50
963.2107	200	25,0	21,0	310,0	60,0	0,35	57,90
963.2108	300	30,0	25,0	310,0	65,0	0,45	75,90
963.2109	400	34,0	18,0	340,0	70,0	0,60	75,90
963.2110	500	36,0	30,0	340,0	75,0	0,66	82,50
963.2111	600	38,0	32,0	340,0	80,0	0,76	90,90
963.2112	700	40,0	34,0	340,0	85,0	0,86	100,50
963.2113	800	42,0	36,0	380,0	90,0	0,97	102,90
963.2114	900	44,0	38,0	380,0	95,0	1,06	112,50
963.2115	1000	45,0	40,0	380,0	100,0	1,17	120,90
963.2116	1300	50,0	42,0	400,0	110,0	1,47	157,50
963.2117	1500	52,0	44,0	400,0	120,0	1,67	181,90
963.2118	2000	54,0	46,0	400,0	130,0	2,20	230,50

BRONZEplus ball pin hammer

- In accordance to DIN 1041
- With hickory handle
- Head and edge areas ground
- Rounded edges
- Non-sparking
- Explosion proof
- Corrosion resistant
- Wear resistant
- Aluminium-Bronze (Non-Ferrous-Alloy)



	g	D mm	L1 mm	L2 mm	kg	€
963.2005	100	15,0	260,0	82,0	0,17	36,50
963.2006	150	16,0	260,0	87,0	0,22	39,50
963.2007	200	19,0	280,0	95,0	0,27	48,50
963.2008	300	23,0	280,0	105,0	0,37	57,90
963.2009	400	25,0	310,0	112,0	0,47	70,90
963.2010	500	27,0	310,0	115,0	0,50	72,90
963.2011	600	29,0	310,0	120,0	0,72	90,90
963.2012	700	30,0	340,0	125,0	0,82	106,90
963.2013	800	33,0	340,0	128,0	0,93	106,90
963.2014	900	34,0	360,0	133,0	1,05	120,90
963.2015	1000	35,0	360,0	136,0	1,15	133,90
963.2016	1250	40,0	380,0	140,0	1,40	139,50
963.2017	1500	42,0	400,0	145,0	1,70	175,50
963.2018	2000	45,0	400,0	155,0	2,30	223,90

BRONZEplus ball pin hammer

- In accordance to DIN 1041
- With fibreglass handle
- Head and edge areas ground
- Rounded edges
- Non-sparking
- Explosion proof
- Corrosion resistant
- Wear resistant
- Aluminium-Bronze (Non-Ferrous-Alloy)

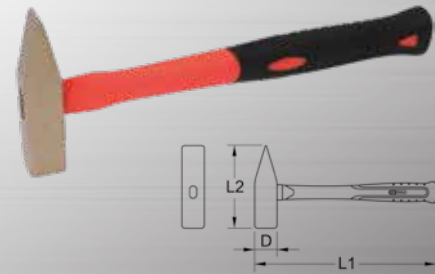

	g	D mm	L1 mm	L2 mm	kg	€
963.2019	300	23,0	310,0	105,0	0,37	66,50
963.2020	400	25,0	310,0	112,0	0,47	79,50
963.2021	500	27,0	310,0	115,0	0,60	84,50
963.2022	800	33,0	340,0	130,0	0,90	115,50
963.2023	1000	35,0	340,0	135,0	1,13	139,50
963.2024	1500	42,0	400,0	145,0	1,70	187,50
963.2025	2000	45,0	400,0	155,0	2,40	266,50

BRONZEplus Sledge hammer

- In accordance to DIN 1042
- With hickory handle
- Head and edge areas ground
- Rounded edges
- Non-sparking
- Explosion proof
- Corrosion resistant
- Wear resistant
- Aluminium-Bronze (Non-Ferrous-Alloy)

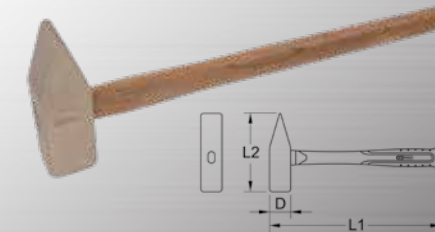

	g	D mm	L1 mm	L2 mm	kg	€
963.2030	2500	50,0	900,0	165,0	3,00	291,50
963.2031	3000	55,0	900,0	175,0	3,70	296,50
963.2032	4000	60,0	900,0	180,0	4,80	393,90
963.2033	5000	68,0	900,0	185,0	5,80	484,90
963.2034	6000	74,0	900,0	190,0	6,80	575,90
963.2035	8000	78,0	900,0	195,0	8,90	745,90
963.2036	9000	82,0	900,0	200,0	9,90	823,90
963.2037	10000	85,0	900,0	210,0	10,90	945,90
963.2038	12000	90,0	900,0	220,0	13,00	1271,50
963.2039	15000	100,0	900,0	230,0	16,00	1575,50

BRONZEplus Sledge hammer

- In accordance to DIN 1041
- With fibreglass handle
- Head and edge areas ground
- Rounded edges
- Non-sparking
- Explosion proof
- Corrosion resistant
- Wear resistant
- Aluminium-Bronze (Non-Ferrous-Alloy)

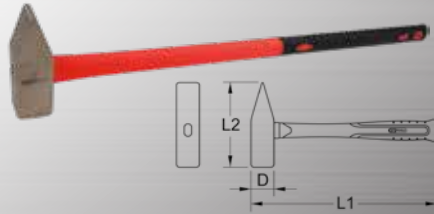

	g	D mm	L1 mm	L2 mm	kg	€
963.2040	3000	55,0	900,0	175,0	4,05	296,50
963.2041	4000	60,0	900,0	180,0	5,10	393,90
963.2042	5000	68,0	900,0	185,0	6,10	478,50
963.2043	8000	78,0	900,0	195,0	9,10	745,90
963.2044	10000	85,0	900,0	210,0	11,15	945,90

BRONZEplus club hammer

- In accordance to DIN 6475
- With hickory handle
- Surfaces polished ground
- Rounded edges
- Non-sparking
- Explosion proof
- Corrosion resistant
- Wear resistant
- Aluminium-Bronze (Non-Ferrous-Alloy)

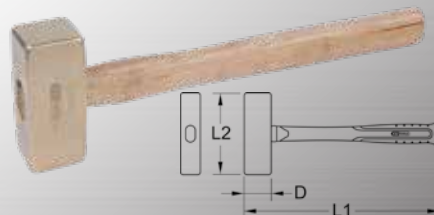

	g	D mm	L1 mm	L2 mm	kg	€
963.2050	1000	40,0	400,0	95,0	1,17	106,90
963.2051	1250	40,0	400,0	115,0	1,40	145,50
963.2052	1500	45,0	400,0	115,0	1,70	157,50
963.2053	2000	50,0	400,0	115,0	2,20	200,50
963.2054	2500	55,0	400,0	130,0	2,70	291,50
963.2055	3000	55,0	900,0	145,0	3,70	296,50
963.2056	4000	60,0	900,0	150,0	4,70	393,90
963.2057	5000	65,0	900,0	170,0	5,70	484,90
963.2058	6000	70,0	900,0	170,0	6,80	696,50
963.2059	8000	75,0	900,0	190,0	8,80	921,50
963.2060	10000	80,0	900,0	210,0	10,90	1036,90



BRONZEplus club hammer

- In accordance to DIN 6475
- With fibreglass handle
- Surfaces polished ground
- Rounded edges
- Non-sparking
- Explosion proof
- Corrosion resistant
- Wear resistant
- Aluminium-Bronze (Non-Ferrous-Alloy)

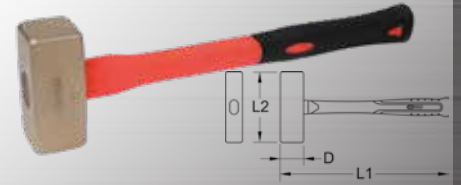

	g	D mm	L1 mm	L2 mm	kg	€
963.2061	1000	40,0	400,0	105,0	1,30	127,50
963.2062	1250	42,0	400,0	110,0	1,60	151,90
963.2063	1500	44,0	400,0	115,0	1,90	205,50
963.2064	2000	48,0	400,0	130,0	2,40	218,50
963.2065	2500	52,0	400,0	150,0	2,90	278,50
963.2066	3000	54,0	900,0	155,0	4,00	327,50
963.2067	4000	58,0	900,0	160,0	5,10	430,50
963.2068	5000	64,0	900,0	165,0	6,10	539,50
963.2069	6000	67,0	900,0	175,0	7,10	618,50
963.2070	8000	75,0	900,0	190,0	9,10	787,50
963.2071	10000	78,0	900,0	205,0	10,10	1036,90

BRONZEplus Mining hammer

- In accordance to DIN 6475
- With hickory handle
- Surfaces polished ground
- Rounded edges
- Non-sparking
- Explosion proof
- Corrosion resistant
- Wear resistant
- Aluminium-Bronze (Non-Ferrous-Alloy)

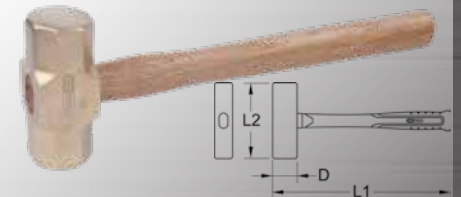

	g	D mm	L1 mm	L2 mm	kg	€
963.2080	1000	40,0	350,0	115,0	1,40	106,90
963.2081	1500	44,0	400,0	118,0	1,95	151,90
963.2082	2500	55,0	400,0	150,0	3,00	241,90
963.2083	3500	58,0	900,0	160,0	4,20	339,50
963.2084	5000	65,0	900,0	175,0	5,75	460,50
963.2085	8000	80,0	900,0	200,0	8,75	763,90

BRONZEplus Mining hammer

- In accordance to DIN 6475
- With fibreglass handle
- Surfaces polished ground
- Rounded edges
- Non-sparking
- Explosion proof
- Corrosion resistant
- Wear resistant
- Aluminium-Bronze (Non-Ferrous-Alloy)

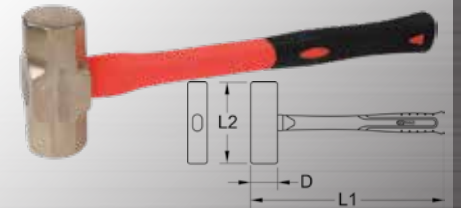

	g	D mm	L1 mm	L2 mm	kg	€
963.2086	1000	40,0	350,0	115,0	1,50	118,90
963.2087	1500	44,0	400,0	118,0	2,05	187,50
963.2088	2500	55,0	400,0	150,0	3,10	278,50
963.2089	3500	58,0	900,0	160,0	4,60	357,50
963.2090	5000	65,0	900,0	175,0	6,10	478,50
963.2091	8000	80,0	900,0	200,0	8,10	763,90

BRONZEplus Hand hammer

- In accordance to DIN 1041
- With hickory handle
- American form
- Surfaces polished ground
- Non-sparking
- Explosion proof
- Corrosion resistant
- Wear resistant
- Aluminium-Bronze (Non-Ferrous-Alloy)

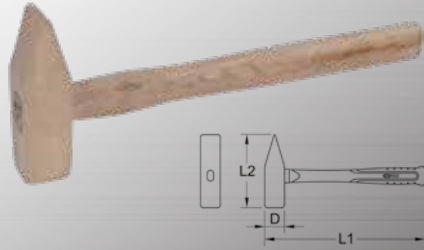

	g	D mm	L1 mm	L2 mm	kg	€
963.2120	700	30,0	310,0	115,0	0,90	94,50
963.2121	1200	40,0	400,0	135,0	1,40	133,90
963.2122	1600	40,0	400,0	140,0	1,85	170,50

BRONZEplus Set hammer

- In accordance to DIN 1041
- With hickory handle
- Head and edge areas ground
- Rounded edges
- Non-sparking
- Explosion proof
- Corrosion resistant
- Wear resistant
- Aluminium-Bronze (Non-Ferrous-Alloy)

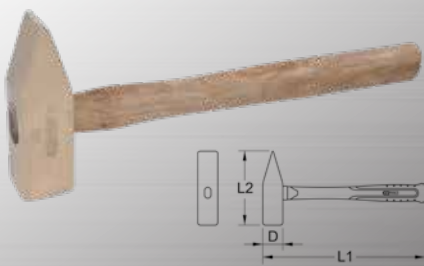

	g	D mm	L1 mm	L2 mm	kg	€
963.2125	1500	42,0	395,0	145,0	1,70	151,90

BRONZEplus Hole/Drift punch

- With hickory handle
- Head and edge areas ground
- Rounded edges
- Non-sparking
- Explosion proof
- Corrosion resistant
- Wear resistant
- Aluminium-Bronze (Non-Ferrous-Alloy)

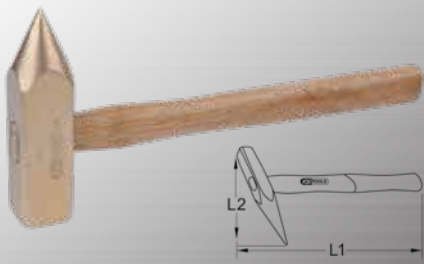

	g	D mm	L1 mm	L2 mm	kg	€
963.2130	1000	32,0	400,0	140,0	1,15	145,50
963.2131	2000	45,0	600,0	160,0	2,15	230,50
963.2132	3000	50,0	900,0	180,0	3,80	309,50
963.2133	5000	60,0	900,0	220,0	5,80	527,50

BRONZEplus machinist's hammer

- With hickory handle
- American form
- Non-sparking
- Explosion proof
- Corrosion resistant
- Wear resistant
- Aluminium-Bronze (Non-Ferrous-Alloy)

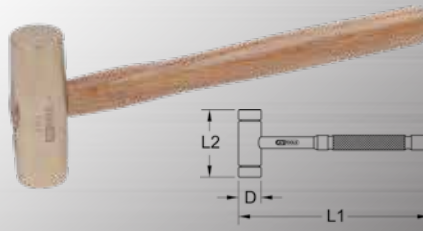

	g	D mm	L1 mm	L2 mm	kg	€
963.2140	100	20,0	310,0	50,0	0,24	16,50
963.2141	300	28,0	310,0	65,0	0,44	42,90
963.2142	500	32,0	310,0	80,0	0,64	72,90
963.2143	600	33,0	340,0	90,0	0,74	82,50
963.2144	800	36,0	340,0	100,0	0,95	109,50
963.2145	900	37,0	380,0	110,0	1,10	118,90
963.2146	1100	38,0	380,0	120,0	1,25	133,90

BRONZEplus claw hammer

- With hickory handle
- Non-sparking
- Explosion proof
- Corrosion resistant
- Wear resistant
- Aluminium-Bronze (Non-Ferrous-Alloy)

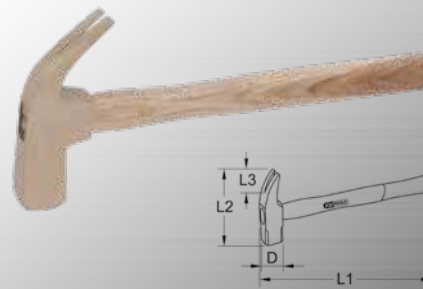

	g	D mm	L1 mm	L2 mm	L3 mm	kg	€
963.2150	300	24,0	310,0	110,0	25,0	440	54,50
963.2151	400	29,0	340,0	120,0	30,0	540	57,90
963.2152	500	32,0	340,0	125,0	30,0	640	70,90
963.2153	600	35,0	340,0	135,0	30,0	740	82,50

BRONZEplus brick hammer

- In accordance to DIN 5108
- With hickory handle
- Non-sparking
- Explosion proof
- Corrosion resistant
- Wear resistant
- Aluminium-Bronze (Non-Ferrous-Alloy)



	g	D mm	L1 mm	L2 mm	S mm	kg	€
963.2160	600	27,0	310,0	120,0	40,0	0,70	79,50
963.2161	800	35,0	310,0	135,0	45,0	0,90	94,50
963.2162	1000	40,0	400,0	145,0	48,0	1,15	118,90

BRONZEplus brick hammer

- With hickory handle
- American form
- Non-sparking
- Explosion proof
- Corrosion resistant
- Wear resistant
- Aluminium-Bronze (Non-Ferrous-Alloy)

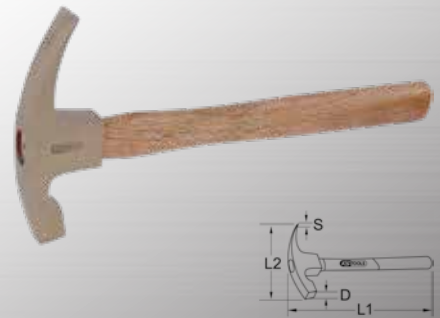

	g	D mm	L1 mm	L2 mm	S mm	kg	€
963.2163	700	22,0	360,0	170,0	34,0	840	100,50

BRONZEplus scaling hammer

- With hickory handle
- Non-sparking
- Explosion proof
- Corrosion resistant
- Wear resistant
- Aluminium-Bronze (Non-Ferrous-Alloy)



	g	L1 mm	L2 mm	S mm	kg	€
963.2170	200	280,0	115,0	19,0	0,25	46,50
963.2171	400	310,0	125,0	27,0	0,50	82,50
963.2172	500	310,0	140,0	30,0	0,62	79,50
963.2173	600	310,0	145,0	32,0	0,75	118,90
963.2174	800	340,0	150,0	35,0	0,95	118,90
963.2175	900	340,0	155,0	38,0	1,10	188,50
963.2176	1400	380,0	160,0	45,0	1,60	187,50

BRONZEplus mallet

- With hickory handle
- Non-sparking
- Explosion proof
- Corrosion resistant
- Wear resistant
- Aluminium-Bronze (Non-Ferrous-Alloy)

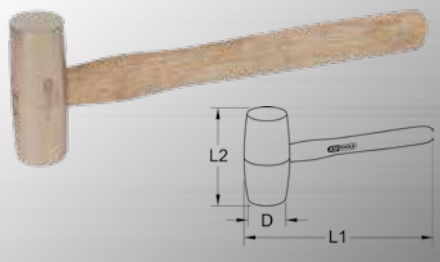

	g	D mm	L1 mm	L2 mm	kg	€
963.2180	900	45,0	380,0	75,0	1,10	118,90
963.2181	1800	60,0	380,0	85,0	2,00	188,50
963.2182	2700	70,0	790,0	90,0	3,00	266,50

BRONZEplus cutoff hammer

- With hickory handle
- Non-sparking
- Explosion proof
- Corrosion resistant
- Wear resistant
- Aluminium-Bronze (Non-Ferrous-Alloy)



	g	D mm	L1 mm	L2 mm	kg	€
963.2595	1300	40,0	400,0	140,0	1,53	170,50
963.2596	2100	45,0	400,0	155,0	2,62	266,50

NON SPARKING AXES

BRONZEplus hoe

- With beech handle
- Non-sparking
- Explosion proof
- Corrosion resistant
- Wear resistant
- Aluminium-Bronze (Non-Ferrous-Alloy)



	S mm	L mm	kg	€
963.9605	120,0	950,0	2,30	236,50

BRONZEplus fireman's axe

- In accordance to DIN 14900
- With hickory handle
- Non-sparking
- Explosion proof
- Corrosion resistant
- Wear resistant
- Aluminium-Bronze (Non-Ferrous-Alloy)



	L1 mm	L2 mm	L3 mm	kg	€
963.9610	800,0	240,0	100,0	2,60	266,50

BRONZEplus pin punch

- With hickory handle
- Non-sparking
- Explosion proof
- Corrosion resistant
- Wear resistant
- Aluminium-Bronze (Non-Ferrous-Alloy)



	g	D mm	L1 mm	L2 mm	kg	€
963.2405	800	8,0	340,0	140,0	0,95	118,90
963.2406	800	10,0	340,0	140,0	0,95	118,90
963.2407	1200	12,0	380,0	160,0	1,40	151,90
963.2408	1200	16,0	380,0	160,0	1,40	151,90

BRONZEplus hatchet

- With hickory handle
- Non-sparking
- Explosion proof
- Corrosion resistant
- Wear resistant
- Aluminium-Bronze (Non-Ferrous-Alloy)

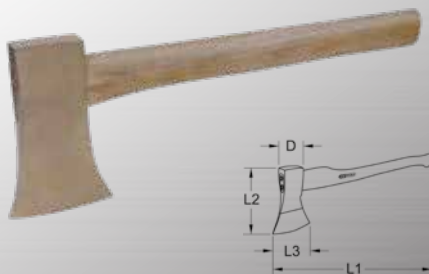

	D mm	L1 mm	L2 mm	L3 mm	kg	€
963.9606	50,0	480,0	155,0	110,0	1,45	133,90
963.9607	70,0	610,0	185,0	110,0	1,50	133,90

BERYLLIUMplus fireman's hatchet

- With fibreglass handle
- Non-sparking
- Explosion proof
- Corrosion resistant
- Very breakage resistant
- Copper Beryllium (Non-Ferrous-Alloy)



	A mm	L1 mm	L2 mm	L3 mm	kg	€
962.9032	27,0	400,0	200,0	85,0	900	236,50

BRONZEplus securing for hammers

- Non-sparking
- Explosion proof
- Corrosion resistant
- Wear resistant
- Aluminium-Bronze (Non-Ferrous-Alloy)



		kg	€
963.5602	up to 2 kg	80	18,50
963.5603	2 - 6 kg	140	25,90

BRONZEplus axe

- With hickory handle
- Non-sparking
- Explosion proof
- Corrosion resistant
- Wear resistant
- Aluminium-Bronze (Non-Ferrous-Alloy)



	D mm	L1 mm	L2 mm	L3 mm	kg	€
963.9608	60,0	750,0	185,0	130,0	1,60	230,50
963.9609	60,0	900,0	185,0	130,0	2,20	296,50

BRONZEplus hand pick

- Non-sparking
- Explosion proof
- Corrosion resistant
- Wear resistant
- Aluminium-Bronze (Non-Ferrous-Alloy)

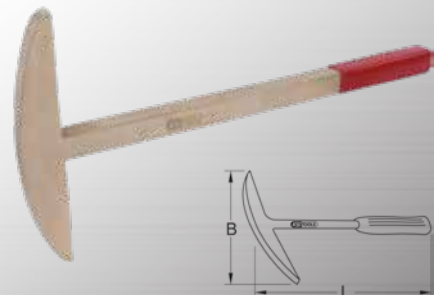

	L mm	B mm	kg	€
963.9611	420,0	220,0	2,15	133,90

NON SPARKING PICKS

BRONZEplus miner's pick

- Without handle
- Non-sparking
- Explosion proof
- Corrosion resistant
- Wear resistant
- Aluminium-Bronze (Non-Ferrous-Alloy)

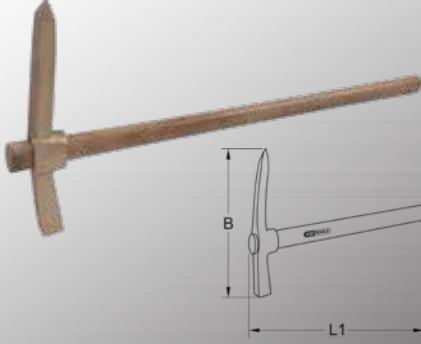

	L mm	B mm	kg	€
963.9612	890,0	400,0	2,20	223,90

BRONZEplus fireman's hook

- In accordance to DIN 14851
- Without handle
- Non-sparking
- Explosion proof
- Corrosion resistant
- Wear resistant
- Aluminium-Bronze (Non-Ferrous-Alloy)



	L mm	Worn mm	kg	€
963.9613	380,0	176,0	1,80	193,90

BRONZEplus pick axe

- In accordance to DIN 20109
- With beech handle
- Non-sparking
- Explosion proof
- Corrosion resistant
- Wear resistant
- Aluminium-Bronze (Non-Ferrous-Alloy)

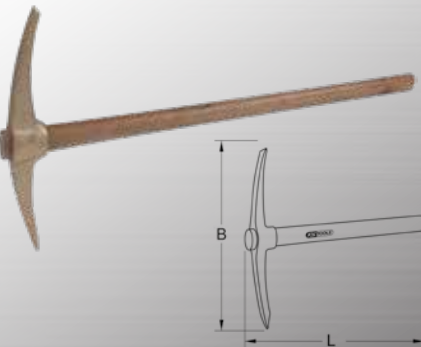

	L mm	B mm	kg	€
963.9620	800,0	400,0	2,15	181,90
963.9621	950,0	500,0	3,50	248,50
963.9622	950,0	550,0	4,00	278,50

BRONZEplus pick axe

- With beech handle
- Non-sparking
- Explosion proof
- Corrosion resistant
- Wear resistant
- Aluminium-Bronze (Non-Ferrous-Alloy)

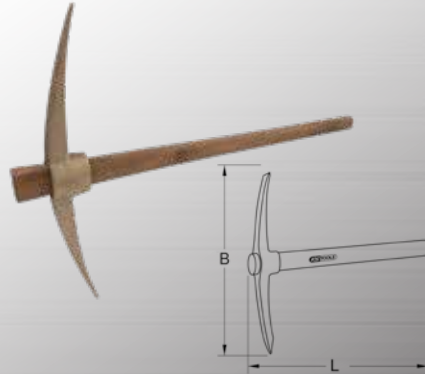

	L mm	B mm	kg	€
963.9623	950,0	650,0	4,10	248,50

NON SPARKING CHISELS

BRONZEplus flat chisel

- In accordance to DIN 6453
- Flat oval form
- Burr-free cutting
- Non-sparking
- Explosion proof
- Corrosion resistant
- Wear resistant
- Aluminium-Bronze (Non-Ferrous-Alloy)

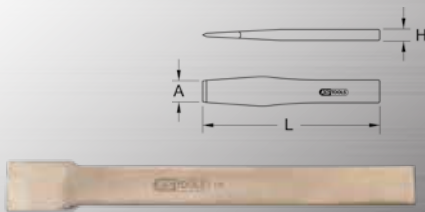

	L mm	A mm	H mm	kg	€
963.2415	150,0	20,0	8,0	200	29,90
963.2416	200,0	25,0	8,0	320	39,50
963.2417	250,0	25,0	10,0	550	57,90
963.2418	300,0	25,0	10,0	560	66,50
963.2419	400,0	30,0	12,0	630	102,90
963.2420	450,0	30,0	12,0	750	109,50
963.2421	500,0	30,0	12,0	920	127,50

BRONZEplus slitting chisel

- Flat oval form
- Burr-free cutting
- Non-sparking
- Explosion proof
- Corrosion resistant
- Wear resistant
- Aluminium-Bronze (Non-Ferrous-Alloy)

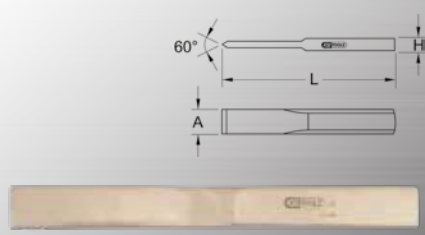

	L mm	A mm	H mm	kg	€
963.2430	200,0	25,0	5,0	360	39,50
963.2431	250,0	25,0	5,0	460	52,50
963.2432	300,0	25,0	5,0	550	72,90

BRONZEplus bricklayer's chisel

- In accordance to DIN 7254
- Burr-free cutting
- 6 point
- Non-sparking
- Explosion proof
- Corrosion resistant
- Wear resistant
- Aluminium-Bronze (Non-Ferrous-Alloy)

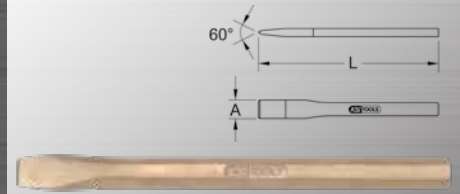

	L mm	A mm	kg	€
963.2440	200,0	6,0	0,15	16,50
963.2441	150,0	8,0	0,04	21,50
963.2442	150,0	10,0	0,12	29,90
963.2443	150,0	14,0	0,20	39,50
963.2444	200,0	14,0	0,25	39,50
963.2445	250,0	14,0	0,30	48,50
963.2446	300,0	14,0	0,40	66,50
963.2447	150,0	17,0	0,30	39,50
963.2448	250,0	17,0	0,45	52,50
963.2449	300,0	17,0	0,55	70,90
963.2450	200,0	19,0	0,50	57,90
963.2451	250,0	19,0	0,60	64,50
963.2452	350,0	19,0	0,85	100,50
963.2453	400,0	19,0	1,00	112,50
963.2454	250,0	22,0	0,85	82,50
963.2455	300,0	22,0	1,00	109,50
963.2456	500,0	22,0	1,60	170,50
963.2457	600,0	22,0	2,00	170,50
963.2458	250,0	27,0	0,58	82,50
963.2459	300,0	32,0	0,85	193,90



BRONZEplus cross cut chisel

- In accordance to DIN 6451
- Flat oval form
- Burr-free cutting
- Non-sparking
- Explosion proof
- Corrosion resistant
- Wear resistant
- Aluminium-Bronze (Non-Ferrous-Alloy)

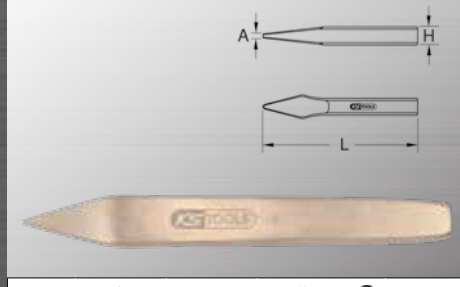

	L mm	A mm	H mm	kg	€
963.2470	150,0	8,0	18,0	250	27,90
963.2471	200,0	8,0	20,0	340	39,50
963.2472	250,0	8,0	22,0	480	52,50
963.2473	300,0	10,0	25,0	640	72,90

BRONZEplus cross cut chisel

- In accordance to DIN 6451
- 6 point
- Burr-free cutting
- Non-sparking
- Explosion proof
- Corrosion resistant
- Wear resistant
- Aluminium-Bronze (Non-Ferrous-Alloy)

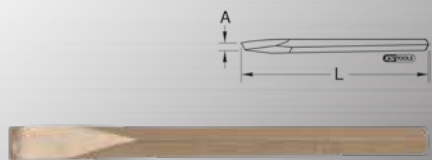

	L mm	A mm	kg	€
963.2480	200,0	14,0	270	39,50
963.2481	250,0	14,0	330	52,50
963.2482	300,0	17,0	550	72,90
963.2483	400,0	19,0	960	106,90

BRONZEplus pointed chisel

- In accordance to DIN 6451
- 6 point
- Burr-free cutting
- Non-sparking
- Explosion proof
- Corrosion resistant
- Wear resistant
- Aluminium-Bronze (Non-Ferrous-Alloy)

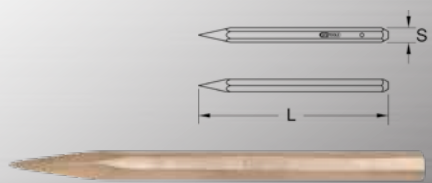

	L mm	S mm	kg	€
963.2490	200,0	14,0	270	39,50
963.2491	250,0	14,0	330	52,50
963.2492	300,0	17,0	550	72,90
963.2493	400,0	19,0	960	102,90

BRONZEplus concrete chisel

- Non-sparking
- Explosion proof
- Corrosion resistant
- Wear resistant
- Aluminium-Bronze (Non-Ferrous-Alloy)

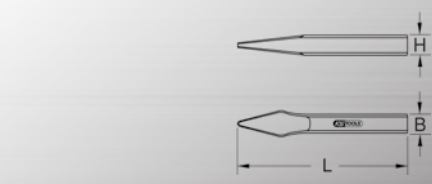

	L mm	H mm	B mm	kg	€
963.2505	380,0	33,0	33,0	5,00	527,50

NON SPARKING PIN PUNCHES & PUNCHES

BRONZEplus scriber

- For marking of work pieces
- Straight and 70° bent tip
- Non-sparking
- Explosion proof
- Corrosion resistant
- Wear resistant
- Aluminium-Bronze (Non-Ferrous-Alloy)



	L mm	Ø mm	kg	€
963.2510	190,0	4,0	50	21,50
963.2511	225,0	6,0	50	27,90

BRONZEplus offset pin

- For marking of work pieces
- Straight and 90° bent tip
- Non-sparking
- Explosion proof
- Corrosion resistant
- Wear resistant
- Aluminium-Bronze (Non-Ferrous-Alloy)

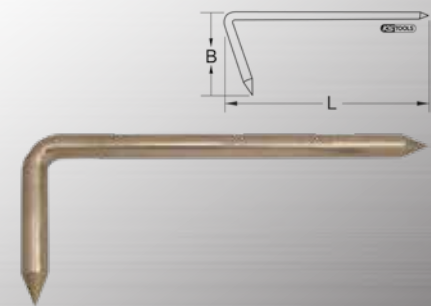

	L mm	B mm	Ø mm	kg	€
963.2515	300,0	100,0	13,0	0,20	57,90
963.2516	450,0	150,0	19,0	1,30	145,50
963.2517	450,0	150,0	16,0	0,93	112,50
963.2518	450,0	150,0	24,0	2,00	211,90
963.2519	450,0	150,0	27,0	2,30	236,50
963.2520	450,0	150,0	30,0	3,30	339,50
963.2521	500,0	150,0	16,0	1,30	284,90
963.2522	600,0	200,0	20,0	2,40	302,90
963.2523	800,0	200,0	22,0	3,40	375,50

BRONZEplus square blade awl

- For piercing and widening of holes
- Two component handle
- Non-sparking
- Explosion proof
- Corrosion resistant
- Wear resistant
- Aluminium-Bronze (Non-Ferrous-Alloy)





	L1 mm	L2 mm	Ø mm	kg	€
963.2525	180,0	100,0	5,0	80	21,50

BRONZEplus pin punch set

- Non-sparking
- Explosion proof
- Corrosion resistant
- Wear resistant
- Aluminium-Bronze (Non-Ferrous-Alloy)
- In a roll bag



	kg	€
963.2560 6 pcs BRONZEplus pin punch set	310	236,50

1 x		4 mm
5 x		1 - 2 - 3 - 4 - 5 mm

BRONZEplus pin punch

- In accordance to DIN 6450
- Conical form
- Strong execution
- Non-sparking
- Explosion proof
- Corrosion resistant
- Wear resistant
- Aluminium-Bronze (Non-Ferrous-Alloy)

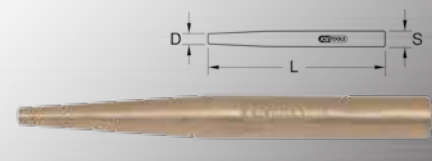

	L mm	D mm	S mm	kg	€
963.2561	120,0	1,0	8,0	40	29,90
963.2562	120,0	2,0	8,0	40	29,90
963.2563	120,0	3,0	8,0	40	34,50
963.2564	120,0	4,0	8,0	40	34,50
963.2565	120,0	5,0	10,0	60	36,50
963.2530	150,0	6,0	13,0	100	36,50
963.2531	150,0	7,0	17,0	100	39,50
963.2532	200,0	8,0	21,0	320	52,50
963.2533	250,0	12,0	24,0	450	82,50
963.2534	250,0	13,0	30,0	600	112,50

BRONZEplus pin punch

- In accordance to DIN 6450
- Conical form
- Extra strong execution
- Non-sparking
- Explosion proof
- Corrosion resistant
- Wear resistant
- Aluminium-Bronze (Non-Ferrous-Alloy)

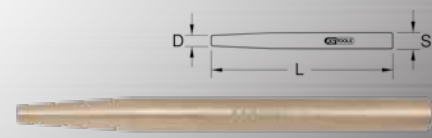

	L mm	D mm	S mm	kg	€
963.2535	220,0	5,0	16,0	280	48,50
963.2536	230,0	10,0	19,0	420	79,50
963.2537	250,0	13,0	24,0	880	118,90

BRONZEplus pin punch

- Barrel type
- Non-sparking
- Explosion proof
- Corrosion resistant
- Wear resistant
- Aluminium-Bronze (Non-Ferrous-Alloy)

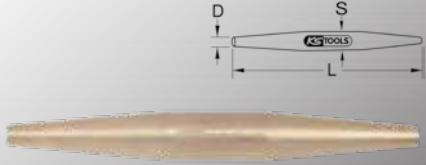

	L mm	D mm	S mm	g	€
963.2540	200,0	8,0	17,0	230	46,50
963.2541	200,0	8,0	21,0	360	52,50
963.2542	200,0	10,0	24,0	270	75,90
963.2543	200,0	13,0	27,0	630	79,50
963.2544	200,0	18,0	30,0	880	112,50
963.2545	200,0	22,0	32,0	1050	115,50

BRONZEplus split pin puncher

- In accordance to DIN 6450
- Non-sparking
- Explosion proof
- Corrosion resistant
- Wear resistant
- Aluminium-Bronze (Non-Ferrous-Alloy)

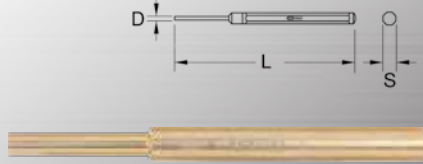

	L mm	D mm	S mm	g	€
963.2591	110,0	3,0	9,0	35	24,90
963.2592	110,0	4,0	10,0	40	29,90
963.2593	120,0	5,0	11,0	78	39,50
963.2594	120,0	6,0	12,0	86	52,50
963.2597	130,0	8,0	14,0	178	57,90
963.2598	140,0	10,0	16,0	205	70,90

BRONZEplus setting punch

- Non-sparking
- Explosion proof
- Corrosion resistant
- Wear resistant
- Aluminium-Bronze (Non-Ferrous-Alloy)

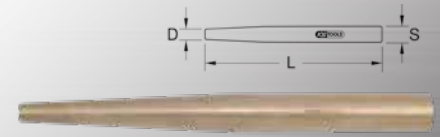

	L mm	D mm	S mm	g	€
963.2580	180,0	5,0	12,0	110	27,90
963.2581	200,0	6,0	13,0	150	39,50
963.2582	200,0	8,0	16,0	220	54,50
963.2583	200,0	9,0	20,0	340	84,50
963.2584	230,0	10,0	22,0	460	112,50
963.2585	250,0	11,0	25,0	620	151,90
963.2586	280,0	12,0	27,0	870	170,50
963.2587	320,0	14,0	30,0	1260	223,90
963.2588	350,0	15,0	32,0	1570	278,50
963.2589	380,0	16,0	36,0	2230	332,90

BRONZEplus centre punch

- In accordance to DIN 7250
- Shaft coded
- Beveled
- Non-sparking
- Explosion proof
- Corrosion resistant
- Wear resistant
- Aluminium-Bronze (Non-Ferrous-Alloy)

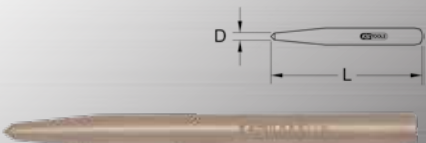

	L mm	D mm	g	€
963.2550	100,0	3,0	30	18,50
963.2551	110,0	4,0	60	18,50
963.2552	125,0	5,0	100	21,50
963.2553	150,0	6,0	200	24,90

BRONZEplus taper punch

- 4 point
- In accordance to DIN 6450
- Non-sparking
- Explosion proof
- Corrosion resistant
- Wear resistant
- Aluminium-Bronze (Non-Ferrous-Alloy)

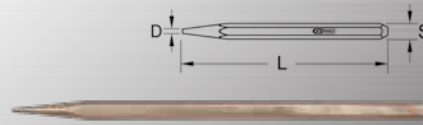

	L mm	D mm	S mm	g	€
963.2566	500,0	5,0	20,0	1,20	211,90

BRONZEplus thread cleaning pin

- Non-sparking
- Explosion proof
- Corrosion resistant
- Wear resistant
- Aluminium-Bronze (Non-Ferrous-Alloy)



	Ø mm	L mm	g	€
963.9505	6,0	300,0	20	21,50
963.9506	10,0	300,0	180	46,50
963.9507	13,0	300,0	350	70,90

BRONZEplus split pin puncher set

- In accordance to DIN 6450
- Non-sparking
- Explosion proof
- Corrosion resistant
- Wear resistant
- Aluminium-Bronze (Non-Ferrous-Alloy)
- In a roll bag



	g	€
963.2590 6 pcs 3 - 4 - 5 - 6 - 8 - 10 mm	440	230,50

BRONZEplus straight pin

- In accordance to DIN 6451
- Non-sparking
- Explosion proof
- Corrosion resistant
- Wear resistant
- Aluminium-Bronze (Non-Ferrous-Alloy)

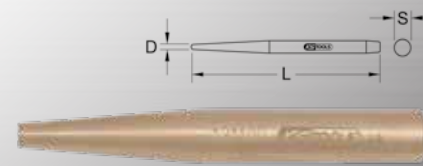

	L mm	D mm	S mm	g	€
963.2570	85,0	8,0	12,0	40	10,90
963.2571	90,0	10,0	14,0	50	16,50
963.2572	100,0	13,0	16,0	70	18,50
963.2573	110,0	16,0	20,0	100	27,90
963.2574	140,0	19,0	25,0	180	39,50
963.2575	160,0	21,0	28,0	270	46,50
963.2576	200,0	25,0	30,0	450	66,50
963.2577	240,0	29,0	35,0	630	79,50

BERYLLIUMplus caulking tool

- Non-sparking
- Explosion proof
- Corrosion resistant
- Very breakage resistant
- Copper Beryllium (Non-Ferrous-Alloy)

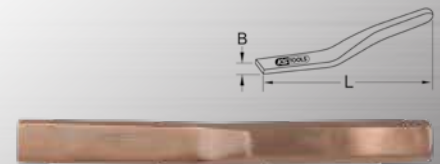

	B mm	L mm	g	€
962.0202	2,0	150,0	370	90,90
962.0203	3,0	160,0	410	100,50
962.0204	4,0	180,0	390	100,50
962.0205	5,0	200,0	520	112,50
962.0206	6,0	200,0	420	112,50
962.0207	7,0	220,0	500	118,90
962.0208	8,0	220,0	520	120,90
962.0209	9,0	220,0	520	127,50
962.0210	10,0	250,0	600	133,90
962.0212	12,0	250,0	540	145,50

NON SPARKING CONSTRUCTION TOOLS

BRONZEplus rust scraper

- Non-sparking
- Explosion proof
- Corrosion resistant
- Wear resistant
- Aluminium-Bronze (Non-Ferrous-Alloy)

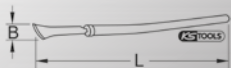

	L mm	B mm	kg	€
963.9545	600,0	75,0	0,53	100,50
963.9546	800,0	75,0	0,62	100,50
963.9547	1000,0	75,0	0,74	100,50
963.9548	1200,0	75,0	1,16	100,50

BRONZEplus brick trowel

- Non-sparking
- Explosion proof
- Corrosion resistant
- Wear resistant
- Aluminium-Bronze (Non-Ferrous-Alloy)

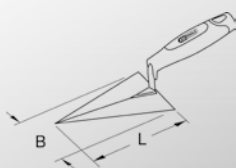

	L mm	B mm	kg	€
963.9550	215,0	130,0	350	170,50
963.9551	240,0	135,0	540	248,50

BRONZEplus plastering trowel

- Non-sparking
- Explosion proof
- Corrosion resistant
- Wear resistant
- Aluminium-Bronze (Non-Ferrous-Alloy)

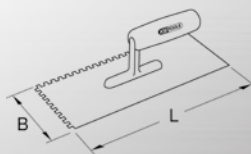

	L mm	B mm	kg	€
963.9552	280,0	120,0	810	357,50

BRONZEplus pointed trowel

- Non-sparking
- Explosion proof
- Corrosion resistant
- Wear resistant
- Aluminium-Bronze (Non-Ferrous-Alloy)

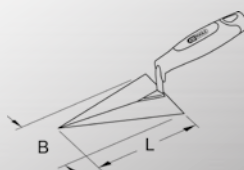

	L mm	B mm	kg	€
963.9553	180,0	92,0	180	145,50

BRONZEplus jointing trowel

- Non-sparking
- Explosion proof
- Corrosion resistant
- Wear resistant
- Aluminium-Bronze (Non-Ferrous-Alloy)

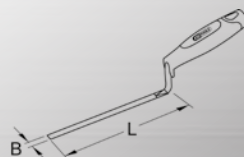

	L mm	B mm	kg	€
963.9554	100,0	10,0	100	57,90

BRONZEplus pick scraper

- Non-sparking
- Explosion proof
- Corrosion resistant
- Wear resistant
- Aluminium-Bronze (Non-Ferrous-Alloy)

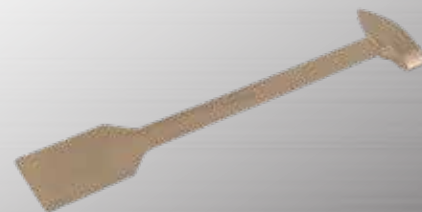

	L mm	B1 mm	B2 mm	D1 mm	D2 mm	L1 mm	L2 mm	kg	€
963.9565	480,0	110,0	70,0	20,0	10,0	40,0	125,0	1,20	133,90

BRONZEplus floor scraper

- Non-sparking
- Explosion proof
- Corrosion resistant
- Wear resistant
- Aluminium-Bronze (Non-Ferrous-Alloy)



	L mm	B mm	kg	€
963.9570	170,0	150,0	720	118,90



BRONZEplus deck scraper

- Non-sparking
- Explosion proof
- Corrosion resistant
- Wear resistant
- Aluminium-Bronze (Non-Ferrous-Alloy)

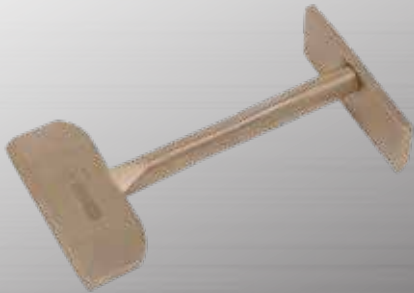

	L mm	B mm	g	€
963.9575	150,0	75,0	500	57,90
963.9576	235,0	125,0	800	88,90

BRONZEplus rubber pusher

- Non-sparking
- Explosion proof
- Corrosion resistant
- Wear resistant
- Aluminium-Bronze (Non-Ferrous-Alloy)

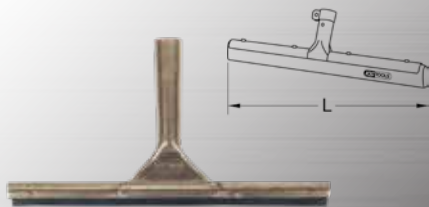

	L mm	g	€
963.9592	300,0	300	34,50

Non-sparking buckets

- Revolving stop handle
- Non-sparking
- Explosion proof
- Corrosion resistant
- Wear resistant



	Material	H mm	D mm	g	€
963.5505	10 brass	270,0	185,0	1,46	405,50
963.5506	12 aluminium	290,0	200,0	0,74	278,50

NON SPARKING SPATULAS

BRONZEplus wide scraper, stiff blade

- With wooden handle
- With hanging hole
- Non-sparking
- Explosion proof
- Corrosion resistant
- Wear resistant
- Aluminium-Bronze (Non-Ferrous-Alloy)

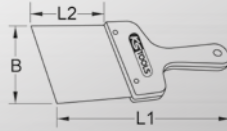

	L1 mm	L2 mm	B mm	g	€
963.9560	195,0	80,0	120,0	250	64,50
963.9561	195,0	80,0	140,0	270	72,90
963.9562	205,0	90,0	160,0	300	84,50
963.9563	205,0	90,0	180,0	350	94,50



BERYLLIUMplus scraper, flexible blade

- With wooden handle
- Non-sparking
- Explosion proof
- Corrosion resistant
- Very breakage resistant
- Copper Beryllium (Non-Ferrous-Alloy)

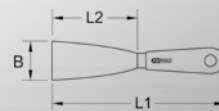

	L1 mm	L2 mm	B mm	g	€
962.0301	200,0	95,0	25,0	75	34,50
962.0302	200,0	95,0	30,0	85	39,50
962.0303	200,0	95,0	40,0	95	46,50
962.0304	200,0	95,0	50,0	105	52,50
962.0305	200,0	95,0	60,0	115	57,90
962.9031	200,0	95,0	75,0	130	57,90
962.0306	200,0	95,0	100,0	145	84,50

BRONZEplus spatula

- With wooden handle
- Non-sparking
- Explosion proof
- Corrosion resistant
- Wear resistant
- Aluminium-Bronze (Non-Ferrous-Alloy)

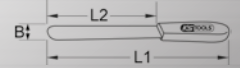

	L1 mm	L2 mm	B mm	g	€
963.9515	260,0	150,0	25,0	350	42,90
963.9516	350,0	230,0	40,0	800	57,90
963.9517	490,0	355,0	50,0	1750	82,50

NON SPARKING SHOVELS & FORKS

BRONZEplus spades

- With beech handle
- Non-sparking
- Explosion proof
- Corrosion resistant
- Wear resistant
- Aluminium-Bronze (Non-Ferrous-Alloy)

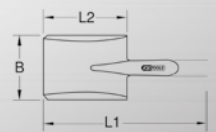

	L1 mm	L2 mm	B mm	g	€
963.9630	1250,0	260,0	180,0	straight 3,50	339,50
963.9631	1250,0	260,0	180,0	D handle 3,65	339,50



BRONZEplus folding spade

- With beech handle
- Non-sparking
- Explosion proof
- Corrosion resistant
- Wear resistant
- Aluminium-Bronze (Non-Ferrous-Alloy)

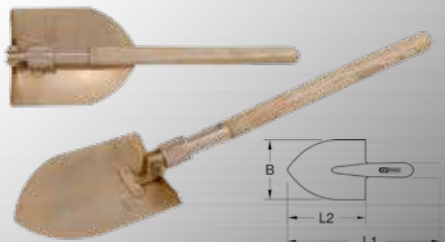

	L1 mm	L2 mm	B mm		€
963.9632	670,0	210,0	160,0	1,30	260,50

BRONZEplus round point shovel

- With beech handle
- Non-sparking
- Explosion proof
- Corrosion resistant
- Wear resistant
- Aluminium-Bronze (Non-Ferrous-Alloy)



	L1 mm	L2 mm	B mm			€
963.9635	1400,0	340,0	260,0	straight	1,85	205,50
963.9636	1000,0	340,0	260,0	D handle	1,85	205,50

BRONZEplus shovel

- With beech handle
- Non-sparking
- Explosion proof
- Corrosion resistant
- Wear resistant
- Aluminium-Bronze (Non-Ferrous-Alloy)



	L1 mm	L2 mm	B mm			€
963.9637	1400,0	400,0	270,0	straight	1,95	223,90
963.9638	1000,0	400,0	270,0	D handle	1,95	223,90

BRONZEplus hand shovel

- With beech handle
- Non-sparking
- Explosion proof
- Corrosion resistant
- Wear resistant
- Aluminium-Bronze (Non-Ferrous-Alloy)



	L1 mm	L2 mm	B mm		€
963.9639	540,0	220,0	180,0	720	106,90

BRONZEplus manure fork

- With beech handle
- Non-sparking
- Explosion proof
- Corrosion resistant
- Wear resistant
- Aluminium-Bronze (Non-Ferrous-Alloy)

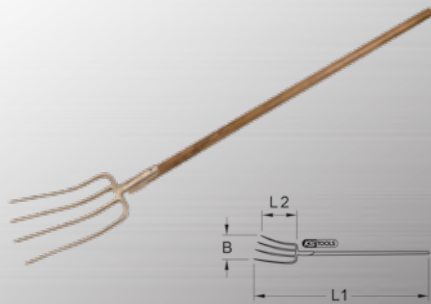

	L1 mm	L2 mm	B mm		€
963.9645	1600,0	330,0	230,0	1,64	496,50

BRONZEplus spade fork

- With beech handle
- Non-sparking
- Explosion proof
- Corrosion resistant
- Wear resistant
- Aluminium-Bronze (Non-Ferrous-Alloy)



	L1 mm	L2 mm	B mm		€
963.9646	1000,0	290,0	180,0	2,10	369,50

BRONZEplus hay fork

- With beech handle
- Non-sparking
- Explosion proof
- Corrosion resistant
- Wear resistant
- Aluminium-Bronze (Non-Ferrous-Alloy)

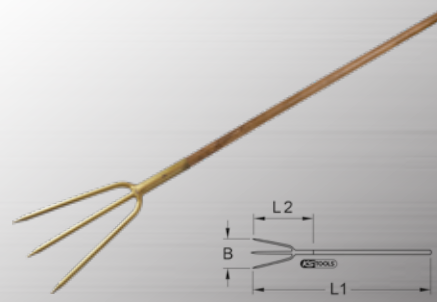

	L1 mm	L2 mm	B mm		€
963.9647	1600,0	290,0	180,0	1,28	448,50

BRONZEplus fork for gun cotton

- Without handle
- Non-sparking
- Explosion proof
- Corrosion resistant
- Wear resistant
- Aluminium-Bronze (Non-Ferrous-Alloy)



	L1 mm	L2 mm	B mm		€
963.9648	200,0	140,0	90,0	0,60	163,90
963.9649	370,0	250,0	150,0	1,80	236,50

BRONZEplus rake

- With beech handle
- Non-sparking
- Explosion proof
- Corrosion resistant
- Wear resistant
- Aluminium-Bronze (Non-Ferrous-Alloy)

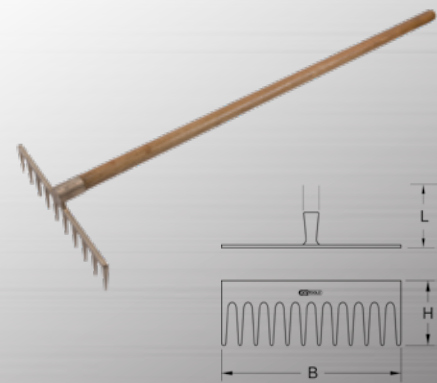

	L mm	B mm	H mm		€
963.9650	1600,0	360,0	90,0	1,53	278,50

NON SPARKING WEDGES

BRONZEplus wedge

- Non-sparking
- Explosion proof
- Corrosion resistant
- Wear resistant
- Aluminium-Bronze (Non-Ferrous-Alloy)

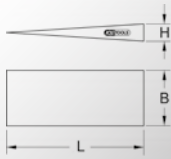

	L mm	B mm	H mm	kg	€
963.2205	80,0	15,0	6,0	0,04	10,90
963.2206	90,0	50,0	10,0	0,20	27,90
963.2207	100,0	50,0	10,0	0,21	27,90
963.2208	105,0	19,0	13,0	0,10	24,90
963.2209	150,0	25,0	13,0	0,25	27,90
963.2210	150,0	30,0	13,0	0,28	36,50
963.2211	150,0	38,0	19,0	0,40	52,50
963.2212	150,0	40,0	13,0	0,35	54,50
963.2213	180,0	32,0	13,0	0,30	42,90
963.2214	180,0	50,0	10,0	0,40	52,50
963.2215	180,0	50,0	19,0	0,70	79,50
963.2216	200,0	38,0	25,0	0,90	100,50
963.2217	200,0	38,0	41,0	1,30	112,50
963.2218	200,0	40,0	40,0	1,38	112,50
963.2219	200,0	50,0	19,0	0,80	75,90
963.2220	215,0	50,0	32,0	1,40	133,90
963.2221	230,0	40,0	20,0	1,00	79,50

BRONZEplus wedge with hole

- Non-sparking
- Explosion proof
- Corrosion resistant
- Wear resistant
- Aluminium-Bronze (Non-Ferrous-Alloy)

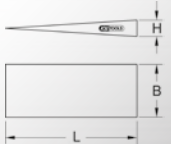

	L mm	B mm	H mm	hole diameter	kg	€
963.2225	100,0	30,0	15,0	6 mm	220	39,50

BRONZEplus space wedge

- Non-sparking
- Explosion proof
- Corrosion resistant
- Wear resistant
- Aluminium-Bronze (Non-Ferrous-Alloy)

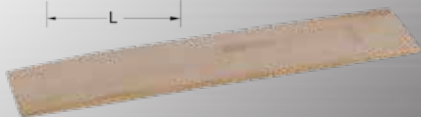

	L mm	B mm	H mm	A mm	kg	€
963.2226	250,0	50,0	5,0	1,2	200	46,50

BRONZEplus nosekey

- for a positive connection of the shaft and hub
- Non-sparking
- Explosion proof
- Corrosion resistant
- Wear resistant
- Aluminium-Bronze (Non-Ferrous-Alloy)



	L mm	B mm	H mm	kg	€
963.2230	340,0	20,0	40,0	2,60	260,50
963.2231	340,0	30,0	40,0	2,80	278,50
963.2232	400,0	30,0	40,0	3,50	314,50

BRONZEplus stone wedge

- Non-sparking
- Explosion proof
- Corrosion resistant
- Wear resistant
- Aluminium-Bronze (Non-Ferrous-Alloy)



	L mm	B mm	H mm	kg	€
963.2235	120,0	50,0	44,0	1,10	170,50
963.2236	150,0	45,0	45,0	1,40	200,50
963.2237	190,0	55,0	47,0	2,00	272,90
963.2238	240,0	60,0	50,0	3,00	369,50

BRONZEplus straight gasket knife with mandrel

- Non-sparking
- Explosion proof
- Corrosion resistant
- Wear resistant
- Aluminium-Bronze (Non-Ferrous-Alloy)

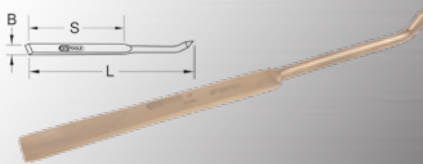

	L mm	B mm	S mm	kg	€
963.9655	400,0	25,0	220	300	170,50

BRONZEplus round gasket knife

- Non-sparking
- Explosion proof
- Corrosion resistant
- Wear resistant
- Aluminium-Bronze (Non-Ferrous-Alloy)



	L mm	B mm	S mm	kg	€
963.9656	690,0	30,0	400	1,20	236,50
963.9657	1240,0	40,0	800	2,00	291,50

NON SPARKING PRY BARS

BRONZEplus pry bar/crowbar

- Non-sparking
- Explosion proof
- Corrosion resistant
- Wear resistant
- Aluminium-Bronze (Non-Ferrous-Alloy)

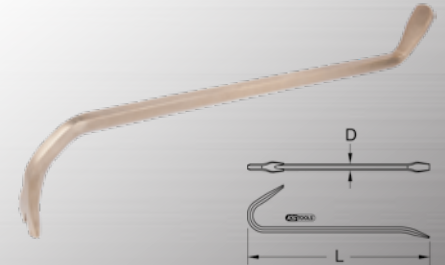

	L mm	D mm	kg	€
963.9705	300,0	14,0	0,40	118,90
963.9706	450,0	9,0	1,10	151,90
963.9707	600,0	19,0	1,50	187,50
963.9708	750,0	22,0	2,50	236,50
963.9709	900,0	22,0	3,00	296,50

BRONZEplus wrecking bar

- Non-sparking
- Explosion proof
- Corrosion resistant
- Wear resistant
- Aluminium-Bronze (Non-Ferrous-Alloy)

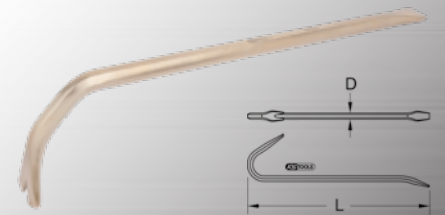

	L mm	D mm	kg	€
963.9715	300,0	14,0	0,40	118,90
963.9716	450,0	19,0	1,10	151,90
963.9717	600,0	19,0	1,50	181,90
963.9718	750,0	22,0	2,50	236,50
963.9719	900,0	22,0	3,00	296,50

NON SPARKING CROWBARS

BRONZEplus crowbar

- Non-sparking
- Explosion proof
- Corrosion resistant
- Wear resistant
- Aluminium-Bronze (Non-Ferrous-Alloy)



	L mm	S mm	kg	€
963.9720	450,0	19,0	1,10	106,90
963.9721	600,0	19,0	1,50	151,90
963.9722	750,0	22,0	2,50	223,90
963.9723	900,0	22,0	3,00	302,90
963.9724	1000,0	22,0	3,30	327,50
963.9725	1250,0	27,0	6,10	514,90
963.9726	1500,0	27,0	7,30	593,90
963.9727	1800,0	30,0	11,10	994,50
963.9728	2000,0	30,0	12,30	1091,50

BRONZEplus crowbar with point and edge

- Non-sparking
- Explosion proof
- Corrosion resistant
- Wear resistant
- Aluminium-Bronze (Non-Ferrous-Alloy)



	L mm	Ø mm		€
963.9730	1000,0	30	6,15	696,50
963.9731	1250,0	30	7,70	763,90
963.9732	1500,0	30	9,25	921,50
963.9733	1800,0	30	11,10	1091,50
963.9734	2000,0	30	12,30	1182,50

BRONZEplus crowbar with point and claw

- Non-sparking
- Explosion proof
- Corrosion resistant
- Wear resistant
- Aluminium-Bronze (Non-Ferrous-Alloy)



	L mm	Ø mm		€
963.9735	1000,0	30	6,15	696,50
963.9736	1250,0	30	7,70	763,90
963.9737	1500,0	30	9,25	921,50
963.9738	1800,0	30	11,10	1091,50
963.9739	2000,0	30	12,30	1182,50

BRONZEplus crowbar with edge and ball end

- Non-sparking
- Explosion proof
- Corrosion resistant
- Wear resistant
- Aluminium-Bronze (Non-Ferrous-Alloy)



	L mm	Ø mm		€
963.9745	1000,0	30	6,15	696,50
963.9746	1250,0	30	7,70	763,90
963.9747	1500,0	30	9,25	921,50
963.9748	1800,0	30	11,10	1091,50
963.9749	2000,0	30	12,30	1182,50

BRONZEplus crowbar with point and ball end

- Non-sparking
- Explosion proof
- Corrosion resistant
- Wear resistant
- Aluminium-Bronze (Non-Ferrous-Alloy)



	L mm	Ø mm		€
963.9755	1000,0	30	6,15	696,50
963.9756	1250,0	30	7,70	763,90
963.9757	1500,0	30	9,25	921,50
963.9758	1800,0	30	11,10	1091,50
963.9759	2000,0	30	12,30	1182,50

BRONZEplus lifting rod

- Non-sparking
- Explosion proof
- Corrosion resistant
- Wear resistant
- Aluminium-Bronze (Non-Ferrous-Alloy)



	L mm	B mm		€
963.9765	650,0	20,0	2,00	236,50
963.9766	800,0	20,0	2,70	314,50
963.9767	1000,0	20,0	3,40	405,50
963.9768	1250,0	25,0	6,20	569,50
963.9769	1500,0	25,0	7,70	732,90

BRONZEplus bending lever

- Non-sparking
- Explosion proof
- Corrosion resistant
- Wear resistant
- Aluminium-Bronze (Non-Ferrous-Alloy)



	L mm	A mm		€
963.9775	200,0	5,0	19	0,66
963.9776	300,0	5,0	19	1,00
963.9777	400,0	5,0	19	1,30
963.9778	500,0	5,0	19	1,60
963.9779	600,0	5,0	19	2,00

BRONZEplus tyre lever

- Non-sparking
- Explosion proof
- Corrosion resistant
- Wear resistant
- Aluminium-Bronze (Non-Ferrous-Alloy)



	L mm	A mm		€
963.9785	200,0	20,0	350	70,90
963.9786	300,0	25,0	470	79,50
963.9787	400,0	30,0	600	88,90
963.9788	500,0	35,0	770	100,50
963.9789	600,0	38,0	900	118,90

BRONZEplus tyre lever, heavy and robust execution

- Non-sparking
- Explosion proof
- Corrosion resistant
- Wear resistant
- Aluminium-Bronze (Non-Ferrous-Alloy)

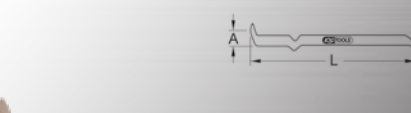

	L mm	A mm		€
963.9790	600,0	25,0	1,00	170,50

BRONZEplus crate opener

- Non-sparking
- Explosion proof
- Corrosion resistant
- Wear resistant
- Aluminium-Bronze (Non-Ferrous-Alloy)



	H mm	L1 mm	L2 mm	L3 mm		€
963.5105	22,0	230,0	70,0	30,0	490	66,50

BRONZEplus carbide drum opener

- Non-sparking
- Explosion proof
- Corrosion resistant
- Wear resistant
- Aluminium-Bronze (Non-Ferrous-Alloy)

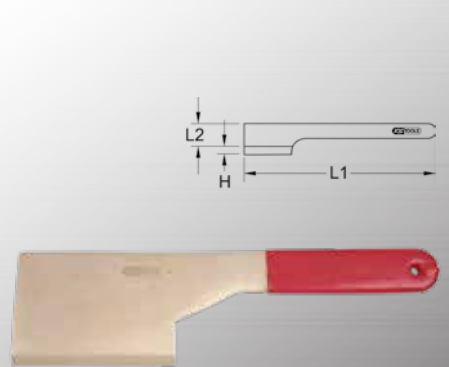

	H mm	L1 mm	L2 mm		€
963.5106	10,0	300,0	75,0	750	90,90

NON SPARKING DRUM LIFTERS

BRONZEplus drum lifter

- Non-sparking
- Explosion proof
- Corrosion resistant
- Wear resistant
- Aluminium-Bronze (Non-Ferrous-Alloy)

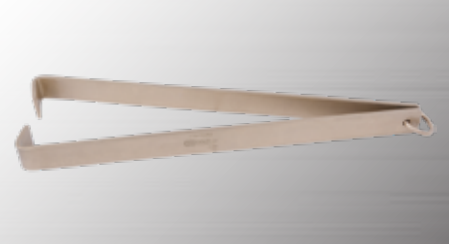

	L mm	Max load kg		€
963.5107	1060,0	600	3,80	405,50

NON SPARKING SHACKLES

BERYLLIUMplus shackle

- Straight design
- Non-sparking
- Explosion proof
- Corrosion resistant
- Very breakage resistant
- Copper Beryllium (Non-Ferrous-Alloy)

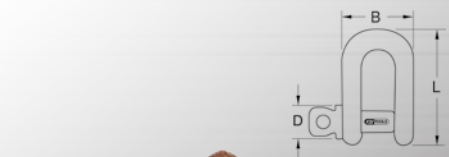

	D mm	L mm	B mm		€
962.9520	25,0	40,0	30,0	100	170,50
962.9521	28,0	78,0	37,0	150	339,50

NON SPARKING PIPE CUTTERS

BRONZE^{plus} pipe cutter

- Non-sparking
- Explosion proof
- Corrosion resistant
- Wear resistant
- Aluminium-Bronze (Non-Ferrous-Alloy)

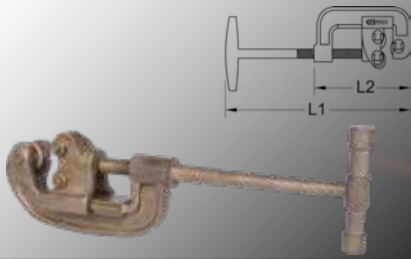

	Ø mm	L1 mm	kg	€
963.5109	50,0	340,0	2,50	575,90

NON SPARKING CLAMPING TOOLS

BRONZE^{plus} tension clamp

- Non-sparking
- Explosion proof
- Corrosion resistant
- Wear resistant
- Aluminium-Bronze (Non-Ferrous-Alloy)

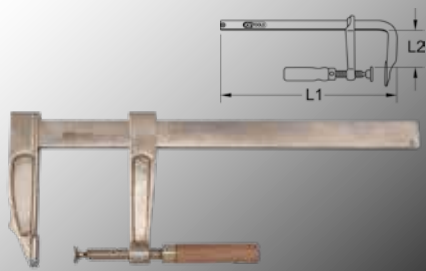

	L1 mm	L2 mm	kg	€
963.5020	480,0	130,0	2,10	393,90

BRONZE^{plus} deep tension clamp

- Non-sparking
- Explosion proof
- Corrosion resistant
- Wear resistant
- Aluminium-Bronze (Non-Ferrous-Alloy)

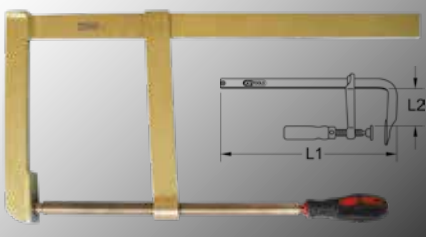

	L1 mm	L2 mm	kg	€
963.5021	480,0	250,0	3,70	569,50

BRONZE^{plus} bench vice

- With swivel base
- Non-sparking
- Explosion proof
- Corrosion resistant
- Wear resistant
- Aluminium-Bronze (Non-Ferrous-Alloy)

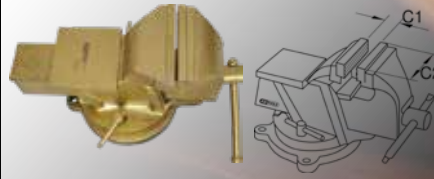

	C1 mm	C2 mm	kg	€
963.5005	100,0	90,0	6,50	1575,50
963.5006	130,0	125,0	15,50	2544,50
963.5007	150,0	150,0	26,50	4241,50
963.5008	170,0	170,0	27,40	5271,90

NON SPARKING NEEDLES

BERYLLIUM^{plus} hearing needle

- Non-sparking
- Explosion proof
- Corrosion resistant
- Very breakage resistant
- Copper Beryllium (Non-Ferrous-Alloy)



	L mm	Ø mm	kg	€
962.0220	250,0	6,0	70	79,50
962.0221	300,0	8,0	150	90,90
962.0222	400,0	7,0	160	90,90
962.0223	500,0	10,0	330	90,90

BERYLLIUM^{plus} hearing needle with ball end

- Non-sparking
- Explosion proof
- Corrosion resistant
- Very breakage resistant
- Copper Beryllium (Non-Ferrous-Alloy)



	L mm	Ø mm	kg	€
962.0224	500,0	6,0	130	72,90

BERYLLIUM^{plus} needle

- Non-sparking
- Explosion proof
- Corrosion resistant
- Very breakage resistant
- Copper Beryllium (Non-Ferrous-Alloy)



	L mm	Ø mm	kg	€
962.0225	180,0	3,0	20	16,50

NON SPARKING OIL PUMPS

BRONZE^{plus} portable manual oil pump

- Non-sparking
- Explosion proof
- Corrosion resistant
- Wear resistant
- Aluminium-Bronze (Non-Ferrous-Alloy)



	L mm	kg	€
963.5805	1350,0	5,00	1271,50

NON SPARKING HOISTS

BRONZE^{plus} hand lift truck

- Pallet truck capacity 2.0 t
- Fork length approx. 1.100 mm
- Guide rod length approx. 1.250 mm
- Non-sparking
- Explosion proof
- Corrosion resistant
- Wear resistant
- Aluminium-Bronze (Non-Ferrous-Alloy)



	Load capacity kg	Total length mm	Width mm	Total depth mm	kg	€
963.5905	2000	1.100,0	470,0	1250,0	120,00	26183,90

BRONZE^{plus} chain hoist

- Non-sparking
- Explosion proof
- Corrosion resistant
- Wear resistant
- Aluminium-Bronze (Non-Ferrous-Alloy)



	Chain length	Max capacity	kg	€
963.9905	2 chains à 2,5 m	0,5 t	10,20	2908,50
963.9906	2 chains à 2,5 m	1,0 t	13,60	3029,50
963.9907	2 chains à 2,5 m	1,5 t	15,60	3574,90
963.9908	2 chains à 2,5 m	2,0 t	22,00	3938,90
963.9909	2 chains à 3 m	3,0 t	23,60	6424,50
963.9910	2 chains à 3 m	5,0 t	36,00	7211,90
963.9911	2 chains à 3 m	10,0 t	68,50	11818,50
963.9912	2 chains à 3 m	16,0 t	187,00	19637,90

Your Local Distributor:

PREMIUM-WERKZEUGE
KS TOOLS
 PREMIUM TOOLS

KS Tools Werkzeuge - Maschinen GmbH

Seligenstädter Grund 10 - 12
 D-63150 Heusenstamm

GERMANY

Tel.: +49(0) 61 04 49 74-0

Fax: +49(0) 61 04 49 74-11

e-mail: kstools@kstools.de

www.kstools.com

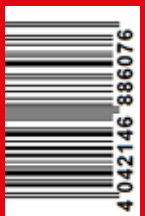

LL22-23EN_EUR